

Low voltage

EasyPact EZC

Moulded-case circuit breakers
from 15 to 630 A

Catalogue
2013



Schneider
Electric

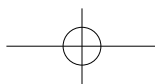
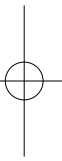
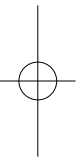
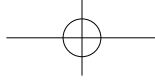

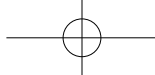

Presentation

2

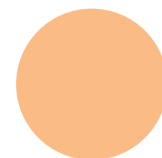

Functions
and characteristics

A-1

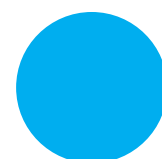

Busbars

B-1

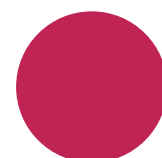

Installation guide

C-1



Catalogue numbers

D-1

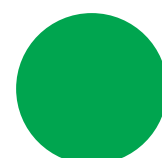

So easy, so simple

With just three sizes of circuit breakers, Schneider Electric's EasyPact™ EZC system is the simple, universal solution to fit all low-voltage protection needs.

- > The fixed version is particularly adapted to the OEM and Building markets, offering optimum performance at a competitive price.
- > The plug-in version offers an additional function dedicated to the Marine market.



Buildings



Marine

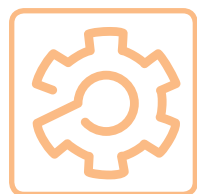

OEM



EasyPact™ EZC range complies with worldwide standards :

- IEC 60947-2
- EN 60947-2
- JISC8201-2-1/C8201-2-2 (annex 1 and 2)
- GB 14048.2
- NEMA-AB1
- UL508 ⁽¹⁾
- CSA22-2 ⁽²⁾
- IACS for Merchant Marine

(International Association of Classification Societies: ABS, BV, CCS, DNV, GL, KRS, LR, NK, RINA)**

⁽¹⁾ Only for the 250A and 400A models

⁽²⁾ Only for the 100A and 250A models

With international certifications and approvals by independent laboratories:

ASEFA, KEMA, TILVA, TÜV, UL

And compliance to RoHS Directive

(Restriction of Hazardous Substances)

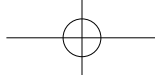

Easy to choose

EasyPact™ EZC brings you easy solutions

- > From 15 A to 630 A
- > Up to 50 kA at 415 V
- > Up to 4 poles
- > In only three frame sizes
- > With a complete range of auxiliaries: rotary commands, auxiliaries, shunt trip, phase barrier, terminal cover, undervoltage trip

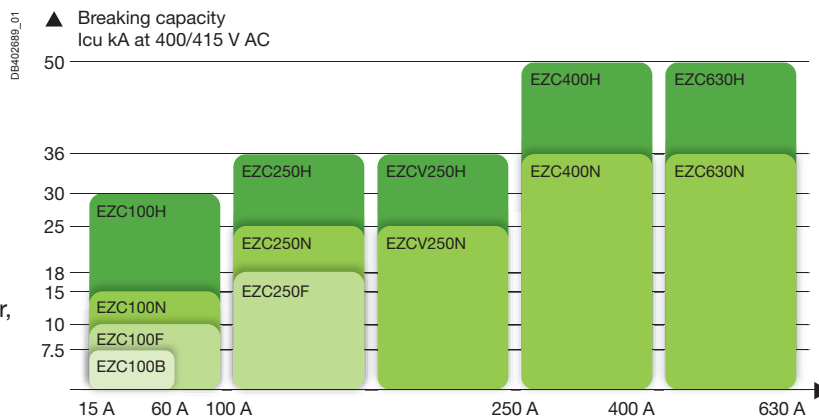

Easy to install

- > Fixed front mounting
- > Plug-in mounting
- > Front connexions
- > Bare cables connected through cable lugs, screwed inside the breaker
- > Field-installable auxiliaries and accessories
- > Built-in earth-leakage protection
- > Interchangeable MCCB and ELCB



Easy to use

- > A thermal calibration suitable for MCCB use at 50 °C without derating
- > Positive contact indication for safety and reliability
- > A smaller case optimized for tight spaces



EasyPact™ EZC:
Build your complete solution with Schneider Electric



Timely delivery, wherever you are

Schneider Electric offers a world-renowned logistics network capable of getting EasyPact™ EZC products to you fast, wherever you are.

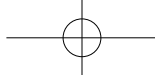

Accessories

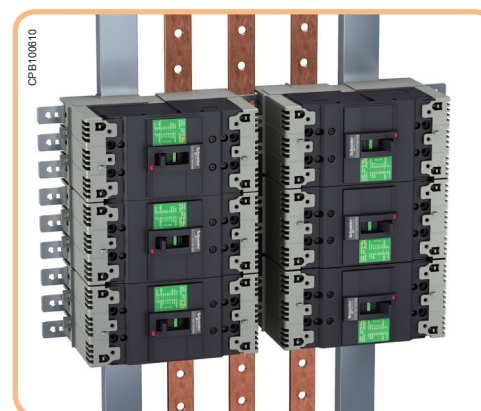
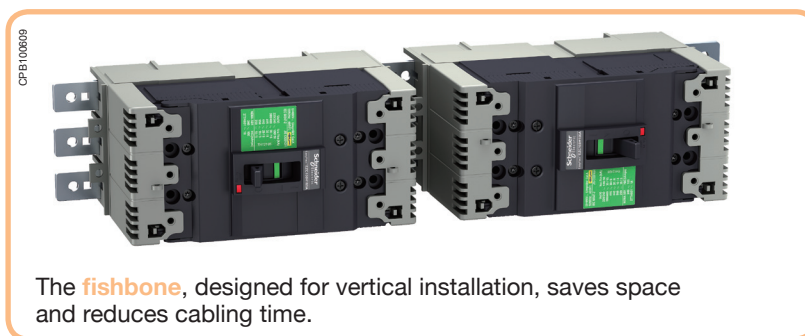
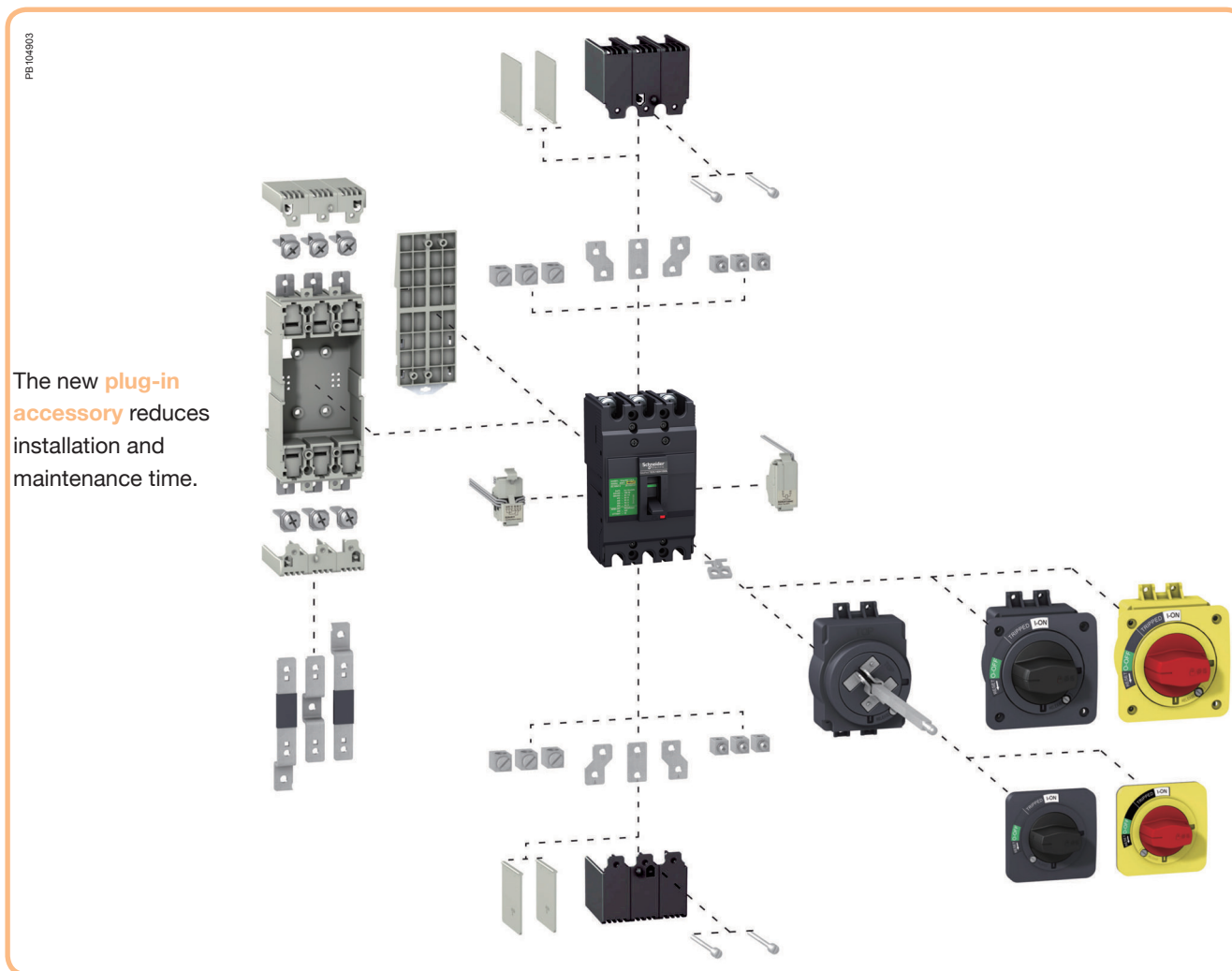

> Make the most of your energy™

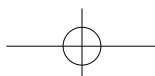

| | |
|---|-------------|
| <i>Presentation</i> | // |
| General characteristics | A-2 |
| Selection table | A-6 |
| Electrical and mechanical accessories overview | |
| EasyPact EZC100 | A-10 |
| EasyPact EZC250 | A-11 |
| EasyPact EZCV250 | A-12 |
| EasyPact EZC400-630 | A-13 |
| Electrical auxiliaries 100-250AF | |
| AX - AL - AXAL - ALV | A-14 |
| SHT - UVR - UVRN | A-16 |
| Direct rotary handle 100-250AF | A-18 |
| Extended rotary handle 100-250AF | A-19 |
| Plug-in | |
| 100 A | A-20 |
| Insulation of live parts | A-21 |
| 250 A | A-22 |
| Insulation of live parts | A-23 |
| Power connections and cable lugs 100-250AF | A-24 |
| Power connections and insulation of live parts 100-250AF | A-25 |
| DIN rail adaptor, padlocking, sealing screws 100-250AF | A-26 |
| Accessories and auxiliaries of EZC400-630 | |
| Connection of devices | A-28 |
| Selection of auxiliaries | A-30 |
| Indication contacts | A-31 |
| Remote tripping | A-32 |
| Rotary handles escutcheons and protection collars | A-33 |
| Locks and sealing accessories | A-34 |
| <i>Busbars</i> | <i>B-1</i> |
| <i>Installation guide</i> | <i>C-1</i> |
| <i>Catalogue numbers</i> | <i>D-1</i> |

Functions and characteristics

General characteristics

CB560611



CB560612

| | | | |
|-------------------------|---------------|----------------------|------|
| $U_i=690V \sim 50/60Hz$ | $U_{imp}=6kV$ | Cat.A | 40°C |
| IEC 60947-2 | $U_e (V)$ | $I_{cu}/I_{cs} (kA)$ | |
| JIS C8201-2-1 | 230/240 | 85 / 43 | |
| | 400/415 | 36 / 18 | |
| | 440 | 25 / 13 | |
| | 550 | 10 / 5 | |
| | 250 | 30 / 15 | |
| NEMA - AB1 | $U (V)$ | HIC (kAmps) | |
| | 240 | 85 | |
| | 277/480 | 25 | |

DL 06253

CB560613

EasyPact™ EZC 250

CE, iT, PG, MEO1

suitable for use at 50°C without derating

75°C Cu Wires
torque 8 - 13 Nm (71 - 115 lb.in)

LISTED MAN. MOTOR CTRL.
27TB Max. CB 800A
Break all Lines

| Short Circuit rating Toggle label | General use | 240 Vac | | 480 Vac | |
|--------------------------------------|-------------|---------|------|---------|------|
| | | 5 kA | 5 kA | 5 kA | 5 kA |
| 183A | 180A | 5 | 10 | 10 | 20 |
| 183A | 184A | 5 | 10 | 10 | 20 |
| 100A | 180A | 5 | 10 | 10 | 20 |
| 125A | 100A | 5 | 10 | 10 | 20 |
| 150A | 120A | 5 | 10 | 10 | 20 |
| 160A | 128A | 5 | 10 | 10 | 20 |
| 175A | 140A | 5 | 10 | 10 | 20 |
| 200A | 160A | 5 | 10 | 10 | 20 |
| 225A | 180A | 5 | 40 | 10 | 20 |
| 250A | 200A | 5 | 40 | 10 | 20 |

GB 14048-2
50Hz F N H
230V~ 25kA 50kA 85kA
400V~ 18kA 25kA 36kA

Merlin Gerin made in China

Example for 250 A frame.

Standardised characteristics indicated on the rating plate:

| | |
|-------------|---|
| U_i : | rated insulation voltage |
| U_{imp} : | rated impulse withstand voltage |
| U_e : | rated operational voltage |
| I_{cu} : | ultimate breaking capacity, for various values of the rated operational voltage U_e |
| Cat: | utilisation category |
| I_{cs} : | service breaking capacity |
| I_n : | rated current |
| $\times I$ | suitability for isolation |

CPB100602



Compliance with standards

EasyPact EZC circuit breakers and auxiliaries comply with the following international standards:

- IEC 60947-1 - general rules
- IEC 60947-2 - low-voltage switchgear and controlgear, part 2 (circuit breakers)
- European (EN 60947-1 and EN 60947-2) and the corresponding national standards
- GB 14048.2
- JIS C8201-2-1 Annex 1 and Annex 2, for molded case circuit breakers
- JIS C8201-2-2 Annex 1 and Annex 2, for earth-leakage circuit breakers
- NEMA-AB1 (High Interrupting Capacity): American standard
- UL508/CSA 22-2 no. 14.

Approvals and Certifications

- IEC certification by independent laboratories (ASEFA, KEMA, TÜV)
- CE marking
- certified by third party Tilva
- certified by third party Underwriter Laboratories as a "Manual Motor Controller" (EZC250/EZCV250).

Vibration and shock withstand test

EasyPact EZC circuit breakers resist mechanical vibrations and shocks. Tests are carried out in compliance with standard IEC 60068-2-6 for the levels required by merchant-marine inspection organisation IACS: International Association of Classification Societies up to 250 A (ABS, BV, DNV, GL, LR, KRS, RINA, NK):

- 2 to 13.2 Hz: amplitude ± 1 mm
- 13.2 to 100 Hz: acceleration 0.7 g.

Pollution degree

EasyPact EZC circuit breakers are certified for operation in pollution-degree III environments as defined by IEC standard 60947 (industrial environments).

Tropicalisation

EasyPact EZC circuit breakers have successfully passed the tests prescribed by the following standards for extreme atmospheric conditions:

- IEC 60068-2-1 - dry cold (-55 °C)
- IEC 60068-2-2 - dry heat (+85 °C)
- IEC 60068-2-30 - damp heat (95 % relative humidity at 55 °C)
- IEC 60068-2-52 - salt mist (severity level 2).

Positive contact indication

All EasyPact EZC circuit breakers are suitable for isolation as defined in IEC standard 60947-2:

- the isolation position corresponds to the O (OFF) position
- the operating handle cannot indicate the O (OFF) position ("green colour" visible) unless the contacts are effectively open
- padlocks may not be installed unless the contacts are open
- installation of a rotary handle does not alter the reliability of the position-indication system.

The isolation function is certified by tests guaranteeing:

- the mechanical reliability of the position indication system
- the absence of leakage currents
- overvoltage withstand capacity between upstream and downstream connections.

EasyPact EZC circuit breakers take into account important concerns for environmental protection. Most components are recyclable and the parts are marked as specified in applicable standards.

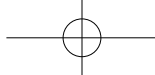

Ambient temperature

- EasyPact EZC circuit breakers has been particularly designed to hold 100 % In at 50 °C without tripping in normal condition (except for earth-leakage circuit breakers).
- EasyPact EZC circuit breakers may be used between -25 °C and +70 °C.
- The permissible storage-temperature range for EasyPact EZC circuit breakers in the original packing is -35 °C to +85 °C.

Installation

EasyPact EZC circuit breakers are designed for easy installation in the various types of switchboards. They may be mounted vertically, horizontally or flat on their back without any derating of characteristics.

Power supply

EasyPact EZC circuit breaker can be supplied from either the top or the bottom (reverse feeding) without any reduction in performance. For earth-leakage circuit breakers, reverse feeding is possible only up to 240 V AC. This capability facilitates connection when installed in a switchboard.

Degree of protection

As per standards IEC 60529 (IP degree of protection) and EN 50102 (IK degree of protection against external mechanical impacts).

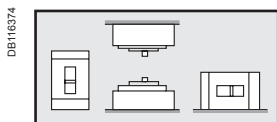

Installation positions.

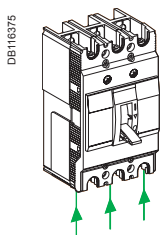

Reverse feeding.

Bare circuit breaker with terminal shields

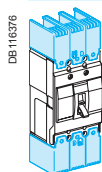

With toggle

IP20

IK07

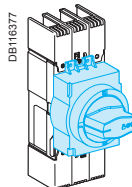

With direct rotary handle standard

IP40

IK07

Circuit breaker installed in a switchboard

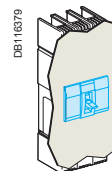
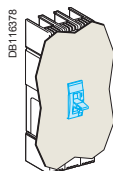

With toggle

IP40

IK07

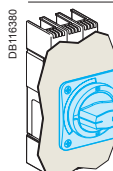

With direct rotary handle standard/VDE MCC

IP54

IK07

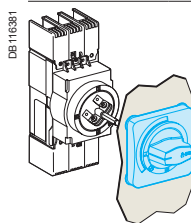

With extended rotary handle

IP54

IK08



Earth-leakage protection

EasyPact EZC circuit breakers have a specific version including earth-leakage protection. This protection is fully integrated inside the breaker and does not require any additional space. EasyPact EZC circuit breakers and earth-leakage circuit breakers are fully interchangeable.

Compliance with standards

EasyPact EZC earth-leakage circuit breakers comply with all the international standards listed [page A-2](#):

- IEC 60947-1
- IEC 60947-2
- EN 60947-1
- EN 60947-2
- GB 14048.2
- JIS C8201-2-2 Annex 1 and Annex 2
- NEMA-AB1 (High Interrupting Capacity)
- UL508/CSA 22-2 no. 14.

They also comply with:

- VDE 664, operation down to -25 °C
- IEC 60255-4 and IEC 60801-2 to 60801-5 covering protection against nuisance tripping due to transient overvoltages, lightning strikes, switching of devices on the distribution system, electrostatic discharges, radiofrequency interference.

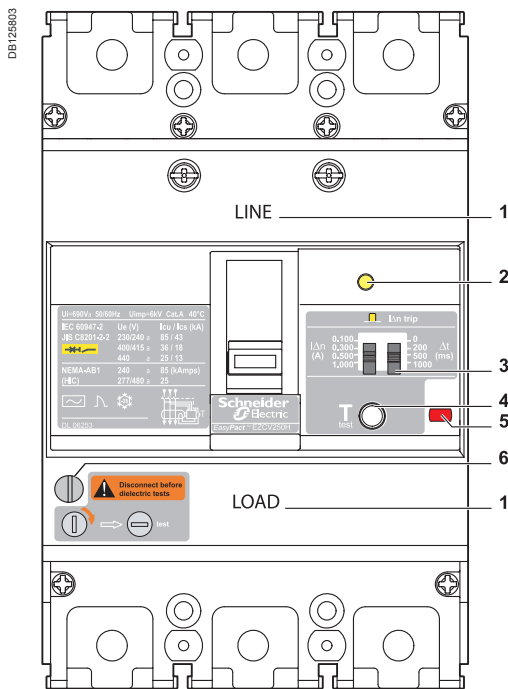

- 1 Line-Load ($U_e > 300$ V AC)
- 2 Mechanical indicator (ELCB)
- 3 Adjustable settings $I_{\Delta n}$ and time delay
- 4 ELCB test button
- 5 Push to trip button (MCCB)
- 6 Dielectric tests: disconnecting switch

Power supply

Reverse feeding

EasyPact EZC earth-leakage circuit breakers can be supplied from either the top or the bottom for voltages up to 300 V AC. For voltages over 300 V AC, only supply from the top is possible (Line-Load indication on the cover of the breaker).

Power supply of the electronics

EasyPact EZC earth-leakage circuit breakers are self-supplied by the distribution-system voltage and therefore do not require any external source. They fully comply with new IEC requirements (Annex B): they are powered from the three phases and continue to function even if one phase is missing.

Dielectric tests

EasyPact EZC earth-leakage circuit breakers are equipped with a disconnecting switch in order to protect the electronics during dielectric tests. When the disconnecting switch is activated, the circuit breaker is automatically tripped. It is mechanically impossible to switch on the circuit breaker, until the earth-leakage function is re-energised.

Tripping features

Tripping indications:

- EasyPact EZC earth-leakage circuit breakers have a yellow mechanical indicator to locally signal tripping due to an earth fault.
- EasyPact EZC earth-leakage circuit breakers may be equipped with an earth-leakage alarm switch (ALV) to remotely signal tripping due to an earth fault.

Resetting

EasyPact EZC earth-leakage circuit breakers are fully reset by the operating handle. After resetting, tripping indicators (mechanical and ALV) come to normal position.

ELCB protection characteristics

| | | | |
|--------------------------------|------------------------|------------|----------------------|
| Sensitivity $I_{\Delta n}$ (A) | | adjustable | 0.1 - 0.3 - 0.5 - 1 |
| Time delay | Intentional delay (ms) | adjustable | 0 - 200 - 500 - 1000 |
| | Max. breaking time (s) | | 0.15 - 0.4 - 1 - 2 |
| Rated voltage | AC 50/60 Hz (V) | | 100...440 |

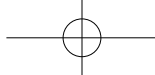

Earth-leakage circuit breakers

With three built-in protections:

- overload
- short-circuit
- earth-leakage.

From 63 A to 250 A

With adjustable sensibility and time delay

Up to 36 kA at 415 V

In 3 poles and 4 poles

DB125805

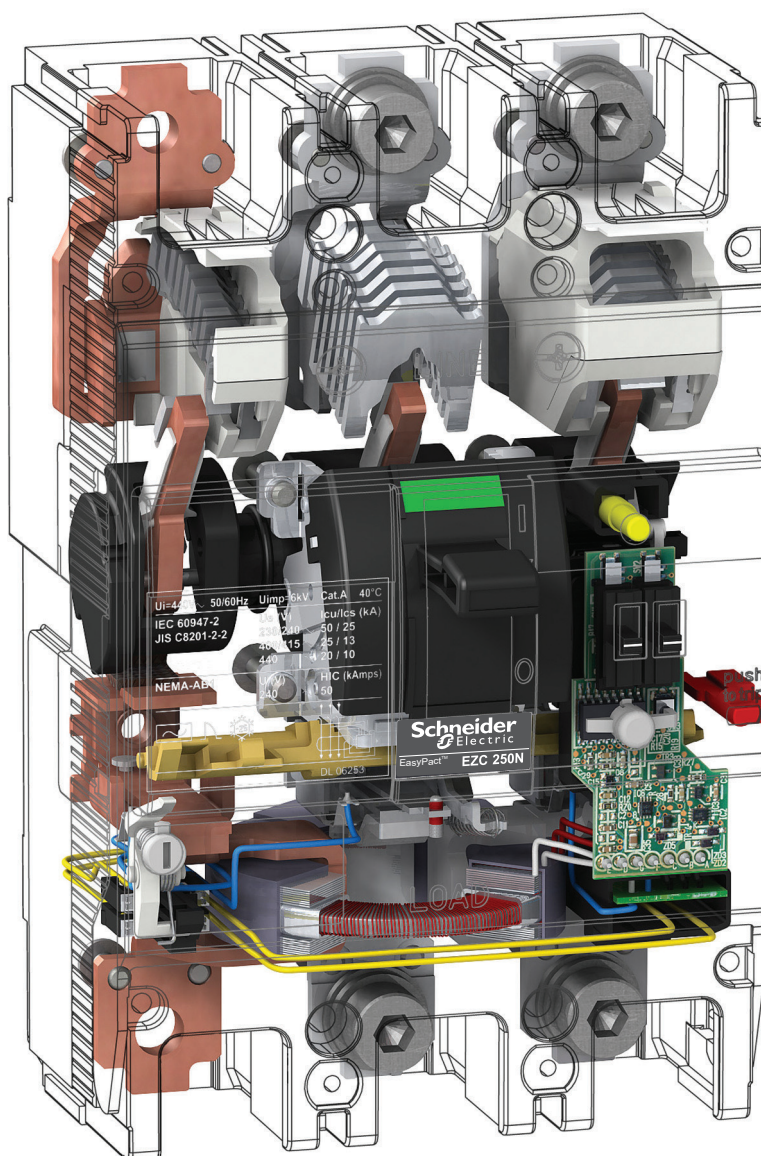

CPB100600



EZC100-1P.

CPB100601



EZC100-2P.

CPB100602



EZC100-3P.

CPB100603



EZC100-4P.

CPB100604



EZC250-3P.

EasyPact EZC circuit breakers

| | | |
|-------------------|-----------|----------|
| Fixed version | | |
| Plug-in version | | |
| Number of poles | | |
| Rated current (A) | In | at 40 °C |

| | | |
|--------------------------------------|-------------|-------------------|
| Rated insulation voltage (V) | Ui | |
| Rated impulse withstand voltage (kV) | Uimp | |
| Rated operational voltage (V) | Ue | AC 50/60 Hz DC |

Electrical characteristics as per IEC 60947-2, EN 60947-2, JIS C8201-2-1

| | | | |
|--|------------|-------------|--|
| Ultimate breaking capacity (kA rms) | Icu | AC 50/60 Hz | 110/130 V |
| | | | 220/230/240 V 380 V 400/415 V 440 V 550 V |
| Rated service breaking capacity (kA rms) | Ics | % Icu | DC 125 V (1P) 250 V (2P in series) |
| | | | 110-400 V 415-550 V |

| | |
|---------------------------|---------------------|
| Suitability for isolation | |
| Utilisation category | |
| Pollution degree | |
| Endurance (C-O cycles) | Mechanical |
| | Electrical In/415 V |

Electrical characteristics as per NEMA-AB1

| | | | |
|----------------------------|------------|-------------|-----------|
| Breaking capacity (kA rms) | HIC | AC 50/60 Hz | 240 V |
| | | | 277/480 V |

Protection

| | |
|--------------------------|------------------------|
| Overload protection | Bimetal |
| Instantaneous protection | Magnetic Fixed (±20 %) |

Auxiliaries

| | | |
|---------------------|----------------------|------|
| Indication contacts | Auxiliary switch | AX |
| | Alarm switch | AL |
| | Combined AX + AL | AXAL |
| Voltage releases | Shunt trip release | SHT |
| | Undervoltage release | UVR |

Installation

| | |
|-------------|--------------------------|
| Connection | Crimp lugs/bars |
| Accessories | Box lugs for bare cables |
| | Rotary handles |
| | Terminal extensions |
| | Spreaders |
| | Phase barriers |
| | Terminal shields |
| | Padlocking system |
| | DIN rail adaptor |

Dimension and weight

| | |
|-----------------|-------|
| Dimensions (mm) | D x H |
| | W |

| | |
|-------------|--|
| Weight (kg) | |
|-------------|--|

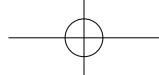

| | EZC100B | EZC100F | EZC100N | EZC100H | | EZC250F | EZC250N | EZC250H | |
|--|--|---|---|---|---|---|--|--|--|
| | ■ | ■ | ■ | ■ | ■ | ■ | ■ | ■ | |
| | ■ | ■ | - | ■ ⁽⁴⁾ | - | ■ | ■ | ■ | |
| | 3 | 3 | 1 | 3-4 | 1 | 2-3-4 | 3 | 2-3 | |
| | 15, 16, 20, 25, 30, 32, 40, 45, 50, 60 | 15, 16, 20, 25, 30, 32, 40, 45, 50, 60, 63, 75, 80, 100 | 15, 16, 20, 25, 30, 32, 40, 45, 50, 60, 63, 75, 80, 100 | 15, 16, 20, 25, 30, 32, 40, 45, 50, 60, 63, 75, 80, 100 | 15, 16, 20, 25, 30, 32, 40, 45, 50, 60, 63, 75, 80, 100 | 15, 16, 20, 25, 30, 32, 40, 45, 50, 60, 63, 75, 80, 100 | 100, 125, 150, 160, 175, 200, 225, 250 | 100, 125, 150, 160, 175, 200, 225, 250 | 100, 125, 150, 160, 175, 200, 225, 250 |
| | 690 | 690 | 690 | 690 | 690 | 690 | 690 | 690 | |
| | 6 | 6 | 6 | 6 | 6 | 6 | 6 | 6 | |
| | 550 | 550 | 415 | 550 | 415 | 550 | 550 | 550 | |
| | - | 250 | 125 | 250 | 125 | 250 | 250 | 250 | |
| | 10 | 25 | 25 | 25 | 50 | 100 | 25 | 50 | 85 |
| | 10 | 25 | 18 | 25 | 25 | 100 ⁽¹⁾ | 25 | 50 | 85 |
| | 7.5 | 10 | 2.5 | 18 | 5 | 30 | 18 | 25 | 36 |
| | 7.5 | 10 | 2.5 | 15 | 5 | 30 | 18 | 25 | 36 |
| | 5 | 7.5 | - | 10 | - | 20 | 15 | 20 | 25 |
| | 2.5 | 5 | - | 5 | - | 10 | 5 | 8 | 10 |
| | - | 5 | 5 | 5 | 10 | 10 | 5 | 20 | 30 |
| | - | 5 | - | 5 | - | 10 | 5 | 20 | 30 |
| | 25 % | 50 % | 50 % | 50 % | 50 % | 50 % | 50 % | 50 % | 50 % |
| | 25 % | 50 % | 50 % | 50 % | 50 % | 25 % | 50 % | 50 % | 50 % |
| | ■ | ■ | ■ | ■ | ■ | ■ | ■ | ■ | |
| | A | A | A | A | A | A | A | A | |
| | 3 | 3 | 3 | 3 | 3 | 3 | 3 | 3 | |
| | 8 500 | 8 500 | 8 500 | 8 500 | 8 500 | 8 500 | 10 000 | 10 000 | 10 000 |
| | 1 500 | 1 500 | 1 500 | 1 500 | 1 500 | 1 500 | 5 000 | 5 000 | 5 000 |
| | - | - | 10 | 25 | 18 | 100 | 25 | 50 | 85 |
| | - | - | 10 ⁽²⁾ | 10 | 18 ⁽²⁾ | 18 ⁽³⁾ | 15 | 18 | 25 ⁽³⁾ |
| | fixed | fixed | fixed | fixed | fixed | fixed | fixed | fixed | fixed |
| | fixed | fixed | fixed | fixed | fixed | fixed | 10 In | 10 In | 10 In |
| | ■ | ■ | - | ■ | - | ■ | ■ | ■ | ■ |
| | ■ | ■ | - | ■ | - | ■ | ■ | ■ | ■ |
| | ■ | ■ | - | ■ | - | ■ | ■ | ■ | ■ |
| | ■ | ■ | - | ■ | - | ■ | ■ | ■ | ■ |
| | ■ | ■ | - | ■ | - | ■ | ■ | ■ | ■ |
| | ■ | ■ | ■ | ■ | ■ | ■ | ■ | ■ | ■ |
| | ■ | ■ | ■ | ■ | ■ | ■ | ■ | ■ | ■ |
| | ■ | ■ | - | ■ | - | ■ ⁽³⁾ | ■ | ■ | ■ |
| | ■ | ■ | - | ■ | - | ■ ⁽³⁾ | ■ | ■ | ■ |
| | - | - | - | - | - | - | ■ | ■ | ■ |
| | ■ | ■ | - | ■ | - | ■ | ■ | ■ | ■ |
| | ■ | ■ | - | ■ | - | ■ ⁽³⁾ | ■ | ■ | ■ |
| | ■ | ■ | ■ | ■ | ■ | ■ | ■ | ■ | ■ |
| | ■ | ■ | ■ | ■ | ■ | ■ | ■ | ■ | ■ |
| | ■ | ■ | ■ | ■ | ■ | ■ | - | - | - |
| | 60 x 130 | 60 x 130 | 60 x 130 | 60 x 130 | 60 x 130 | 60 x 130 | 60 x 165 | 60 x 165 | 60 x 165 |
| | 75 | 75 | 25 | 75 (3P) 100 (4P) | 25 | 50 (2P) 75 (3P) 100 (4P) | 105 | 105 | 105 |
| | 0.78 | 0.78 | 0.28 | 0.78 (3P) 1.0 (4P) | 0.28 | 0.6 (2P) 0.78 (3P) 1.0 (4P) | 1.3 | 1.3 | 1.1 (2P) 1.3 (3P) |

(1) 50 kA for 2 poles.
(2) For 277 V only.
(3) For 3 and 4 poles only.
(4) For 3P only.



EZC250-4P.



EZCV250-4P.



EZC400-3P.

EasyPact EZC circuit breakers

| | | |
|-------------------|----------------------|----------|
| Fixed version | | |
| Plug-in version | | |
| Number of poles | | |
| Rated current (A) | I_n | at 40 °C |

| | | |
|--------------------------------------|------------------------|-------------------|
| Rated insulation voltage (V) | U_i | |
| Rated impulse withstand voltage (kV) | U_{imp} | |
| Rated operational voltage (V) | U_e | AC 50/60 Hz DC |

Electrical characteristics as per IEC 60947-2, EN 60947-2 and JIS C8201-2-1/C8201-2-2

| | | | |
|-------------------------------------|-----------------------|-------------|--|
| Ultimate breaking capacity (kA rms) | I_{cu} | AC 50/60 Hz | 220/230 V 380 V 400/415 V 440 V 550 V |
| | | DC | 125 V (1P) 250 V (2P in series) |

| | | |
|--|-----------------------|-------------------|
| Rated service breaking capacity (kA rms) | I_{cs} | % I _{cu} |
| Suitability for isolation | | |
| Utilisation category | | |
| Pollution degree | | |
| Endurance (C-O cycles) | Mechanical | |
| | Electrical | In/415 V |

Electrical characteristics as per NEMA-AB1

| | | | |
|----------------------------|------------|-------------|--------------------|
| Breaking capacity (kA rms) | HIC | AC 50/60 Hz | 240 V 277/480 V |
|----------------------------|------------|-------------|--------------------|

Protection

| | | |
|--------------------------|----------|----------------|
| Overload protection | Bimetal | |
| Instantaneous protection | Magnetic | fixed (± 20 %) |

Earth-leakage protection

| | | |
|------------------------|-----------------------|------------|
| Sensitivity (A) | I_{Δn} | adjustable |
| Time-delay (ms) | Δt | adjustable |
| Max. breaking time (s) | at 2 I _{Δn} | |

Auxiliaries

| | | |
|---------------------|----------------------|--------|
| Indication contacts | Auxiliary switch | OF/AX |
| | Alarm switch | SD/AL |
| | Combined AX + AL | AXAL |
| | Earth-alarm switch | ALV |
| Voltage releases | Shunt trip release | MX/SHT |
| | Undervoltage release | MN/UVR |

Installation

| | |
|-------------|--------------------------|
| Connection | Crimp lugs / bars |
| Accessories | Box lugs for bare cables |
| | Rotary handles |
| | Terminal extensions |
| | Spreaders |
| | Phase barriers |
| | Terminal shields |
| | Padlocking system |

Dimension and weight

| | |
|-----------------|-------|
| Dimensions (mm) | D x H |
| | W |

| | |
|-------------|--|
| Weight (kg) | |
|-------------|--|

Electrical and mechanical accessories overview

EasyPact EZC100

EasyPact EZC circuit breaker EZC100 comes with a full range of accessories to fulfill different application requirements and make it easy for the end-user.

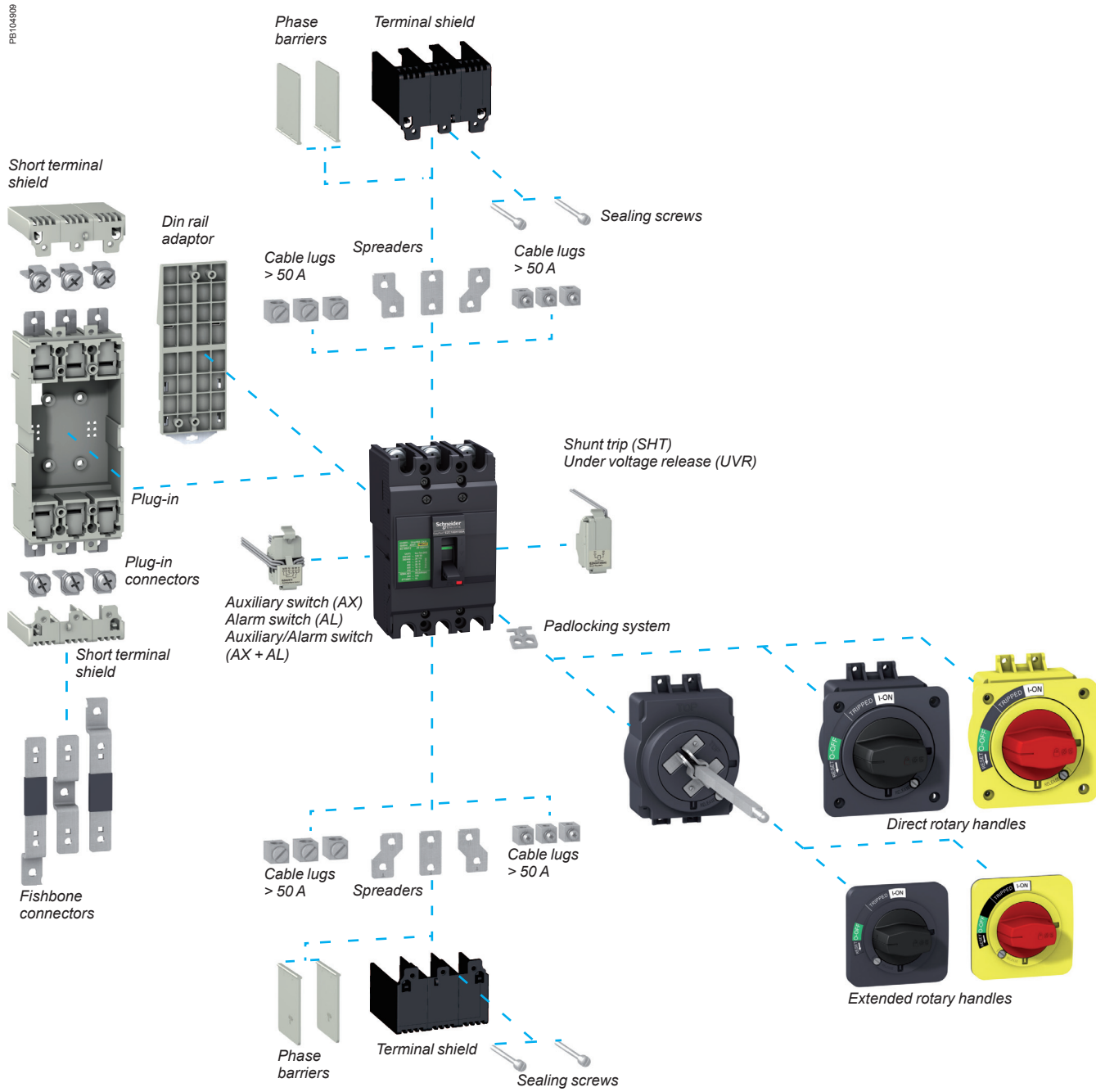

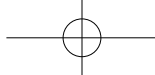

EasyPact EZC250

EasyPact EZC circuit breaker EZC250 comes with a full range of accessories to fulfill different application requirements and make it easy for the end-user.

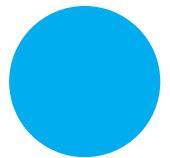
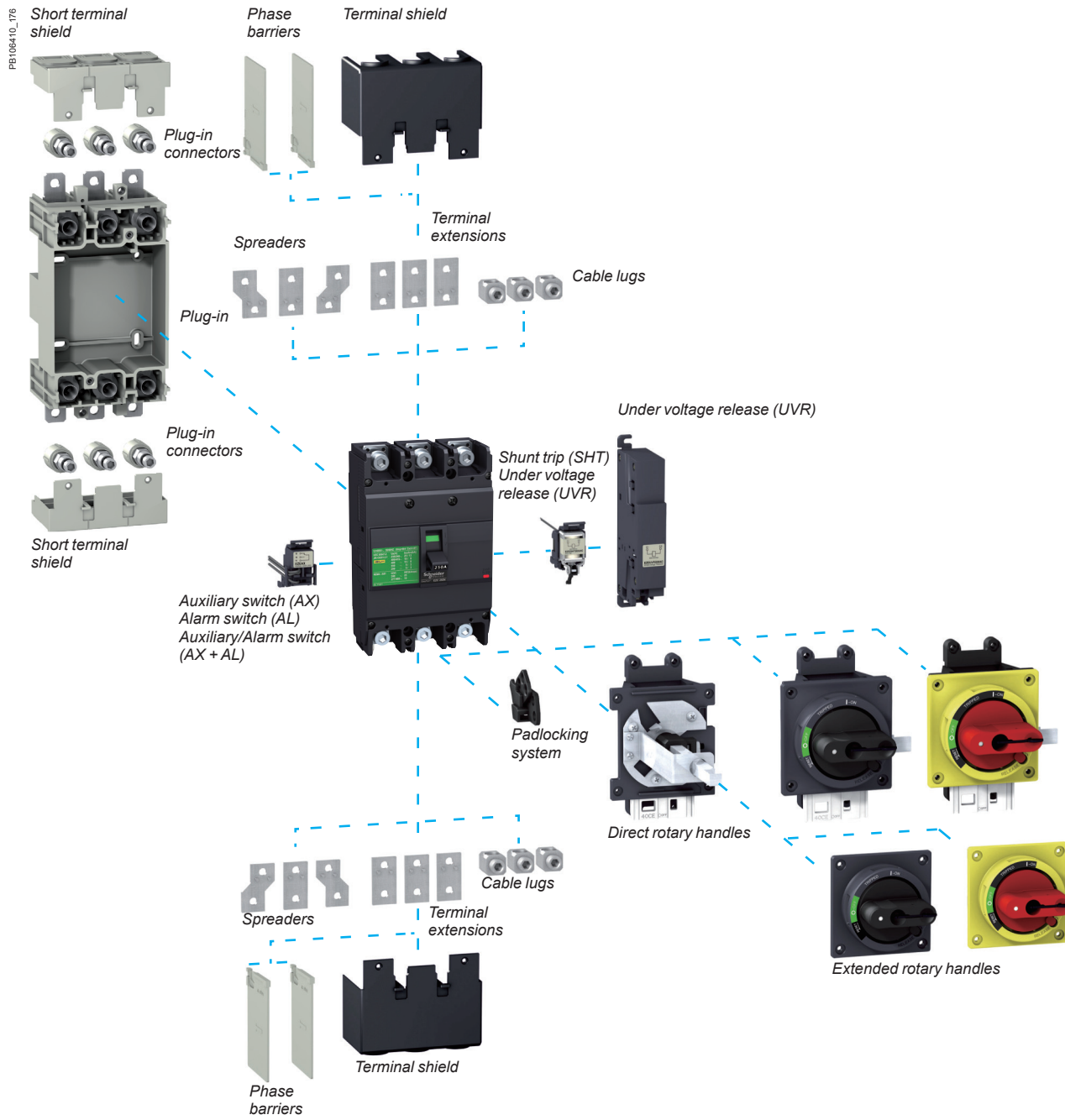



Functions and characteristics

Electrical and mechanical accessories overview

EasyPact EZCV250

EasyPact EZC circuit breaker EZCV250 comes with a full range of accessories to fulfill different application requirements and make it easy for the end-user.

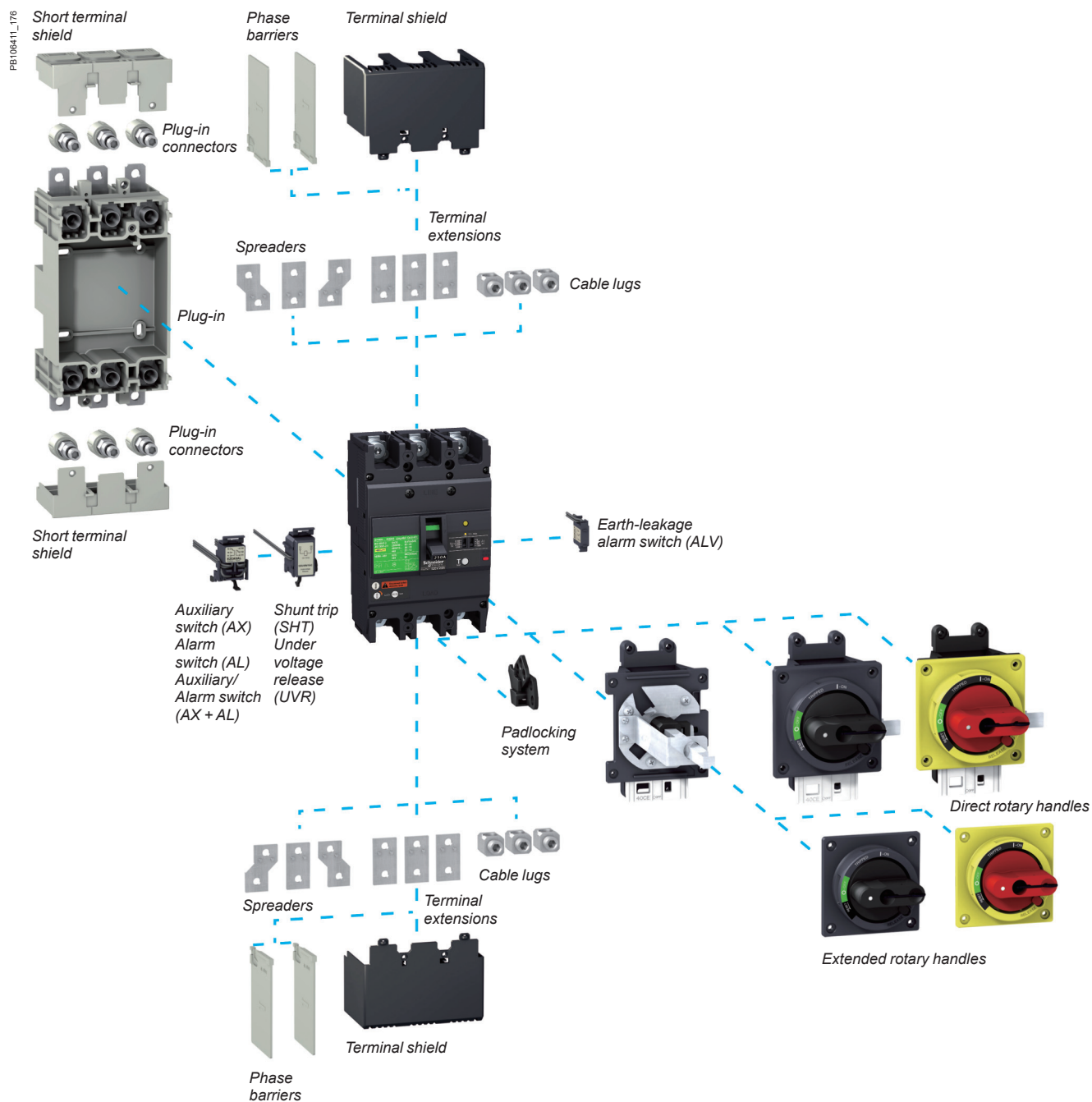

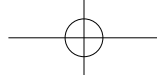

EasyPact Ezc400-630

EasyPact Ezc circuit breaker Ezc400-630 comes with a full range of accessories to fulfill different application requirements and make it easy for the end-user.

Insulation accessories

DB400001_1

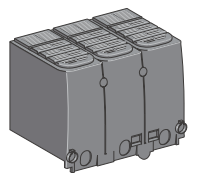

Sealable terminal shields

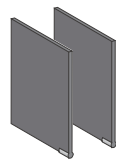

Interphase barriers

Connection

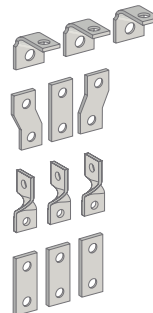

Terminal extensions

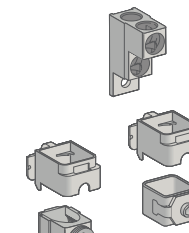

Cable connectors

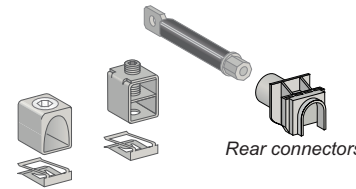

Cable connectors

Rear connectors

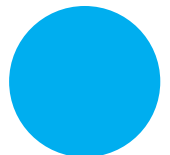

Electrical auxiliaries



Indication contact



Voltage release

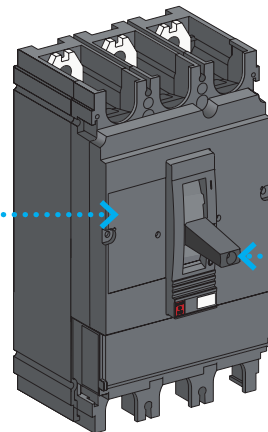

Control accessories

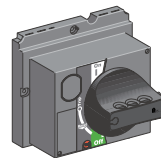

Direct rotary handle

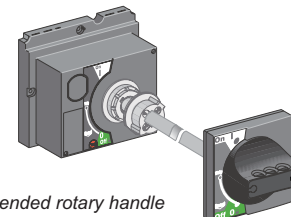

Extended rotary handle

Electrical auxiliaries 100-250AF AX - AL - AXAL - ALV



EZC100.

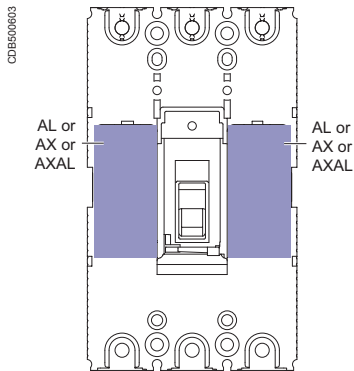

AXAL and AX electrical auxiliaries on EZC100.

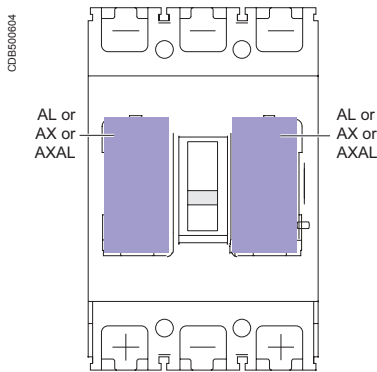

AXAL electrical auxiliaries on EZC250.

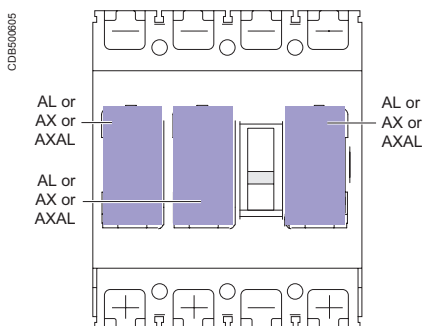

AXAL, AX and ALV electrical auxiliaries on EZCV250.

Plug-in location: AX - AL - AXAL - ALV

EZC100

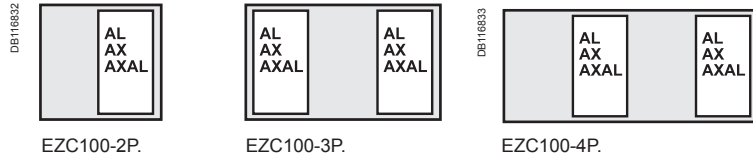

EZC250

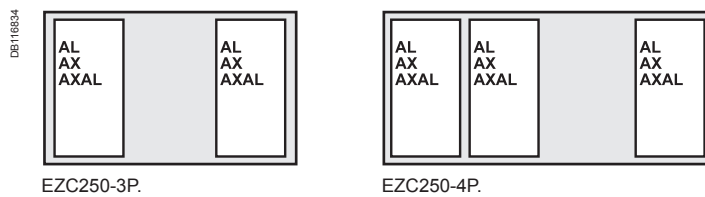

EZCV250

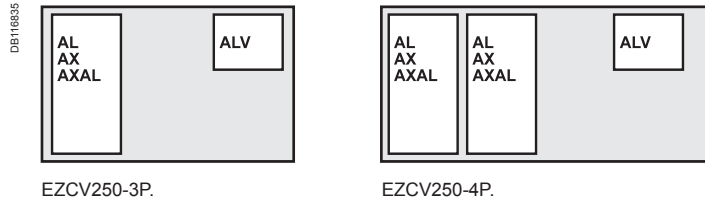

Indication contacts

Provide remote circuit breaker status information. They can be used for indications, electrical locking, relaying, etc. Common-point changeover contacts.

Auxiliary switch (ON/OFF)

AX indicates the position of the circuit breaker contacts.

Alarm switch (trip indication)

■ AL indicates that the circuit breaker has tripped due to:

- an overload
- a short-circuit
- operation of a voltage release.

■ ALV indicates that the circuit breaker has tripped due to an of earth-leakage fault.

They return to de-energised state when the circuit breaker is reset.

Characteristics

| Contacts | | | | |
|--------------------------------------|-------------------------------------|------|------|------|
| Rated thermal current (A) | 5 | | | |
| Minimum load | 10 mA at 24 V | | | |
| Utilisation category (IEC 60947-5-1) | AC12 | AC15 | DC12 | DC14 |
| Operational current (A) | 24 V | 5 | 5 | 4 |
| | 48 V | 5 | 5 | 2.5 |
| | 125 V | 5 | 3 | 0.4 |
| | 250 V | 3 | 2 | 0.2 |
| Connections | | | | |
| Connection wire length | 450 mm | | | |
| Cross-section | EZC100: 1 mm ² , | | | |
| | EZC250/EZCV250: 1.5 mm ² | | | |

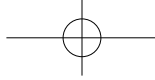

PE101882-21



Auxiliary switch (AX)
EZAUX10.

PE101876-21



Auxiliary switch (AX)
EZEAX.

DE116386

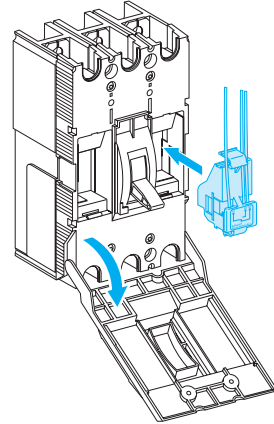

PE101893-28



Earth-leakage alarm switch
(ALV).

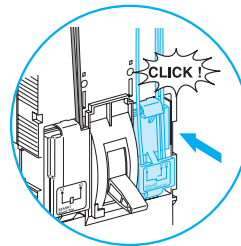

All EasyPact EZC
electrical auxiliaries
are "snapped in place"

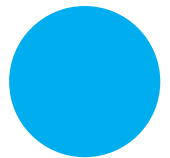

Electrical auxiliaries

100-250AF

SHT - UVR - UVRN



EZC250.

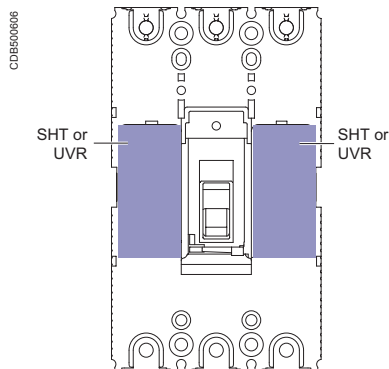

SHT and UVR releases on Ezc100.

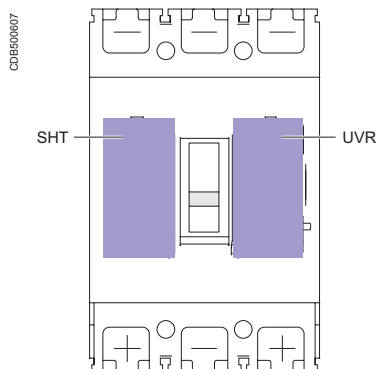

SHT and UVR releases on Ezc250.

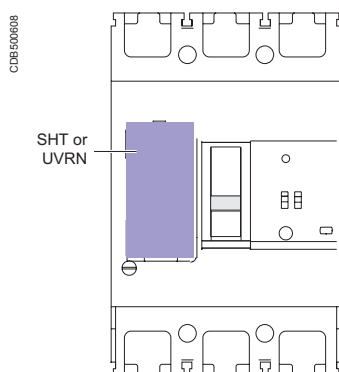

UVRN release on EzcV250.

Plug-in location : SHT - UVR - UVRN

EZC100

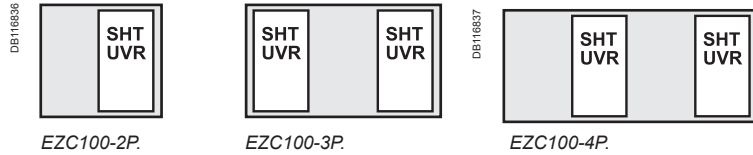

EZC250

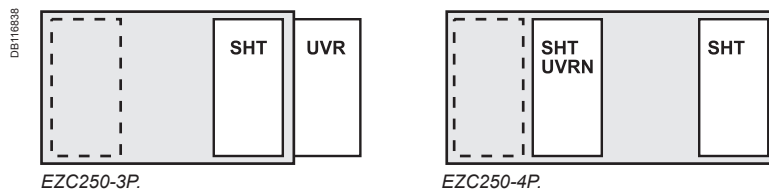

EZCV250

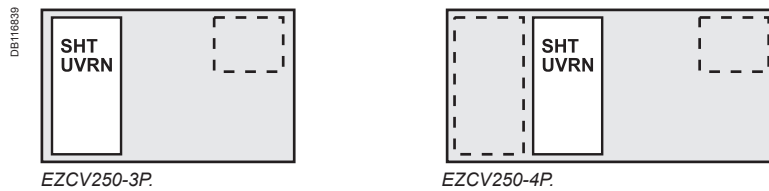

Remote tripping

Shunt Trip (SHT) or Under Voltage Release (UVR/UVRN).

Shunt Trip (SHT)

- This release trips the circuit breaker when the control voltage rises above $0.7 \times U_n$
- Control signals can be of the impulse type (≥ 20 ms) or maintained.

Under Voltage Release (UVR/UVRN)

- This release trips the circuit breaker when the control voltage drops below a tripping threshold
- Tripping threshold between 0.35 and 0.7 times the rated voltage
- Circuit breaker closing is possible only if the voltage exceeds 0.85 times the rated voltage.

Operation

When the circuit breaker has been tripped by an SHT or UVR/UVRN release, it must be reset locally:

- SHT or UVR/UVRN tripping takes priority over manual closing
- in the presence of a standing trip order, closing of the contacts, even temporary, is not possible.

Circuit breaker tripping by an SHT/UVR/UVRN release meets the requirements of standard IEC 60947-2.

Characteristics

| Mechanical | | | |
|----------------------|-----------------------------------|--------------------------------|----------------------------------|
| Mechanical endurance | 10 % of MCCB mechanical endurance | | |
| Electrical | | EZC100 | EZC250/EZCV250 |
| | | AC/DC | AC DC |
| SHT | pick-up consumption | < 30 VA | < 35 W |
| | response time | < 50 ms | < 100 ms |
| UVR | seal-in consumption | < 5 VA | < 10 W |
| | response time | < 50 ms | < 100 ms |
| UVRN | seal-in consumption | < 5 VA | < 10 W |
| | response time | < 50 ms | < 100 ms |
| Connections | | EZC100 | EZC250/EZCV250 |
| SHT | | pre-wired (1 mm ²) | pre-wired (0.5 mm ²) |
| UVR | | pre-wired (1 mm ²) | screws (< 2 mm ²) |
| UVRN | | pre-wired (1 mm ²) | pre-wired (0.5 mm ²) |



PE101865-16



Shunt Trip EZASHT.

PE101879-18



Shunt Trip EZESHT.

Installation

- Ezc100 SHT and UVR: internal mounting
- Ezc250/EzcV250:
- SHT: internal mounting
- UVR: external mounting
- UVRN: internal mounting

PE101866-18



Under Voltage Release EZAUVR.

PE101894-27



Under Voltage Release EZEUVRN.

PE101860-15



Under Voltage Release EZEUVR.

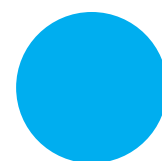

Functions and characteristics

Direct rotary handle 100-250AF

PE101867-31



Direct rotary handle (black) for EZC100.

PE102165-30



Direct rotary handle (red/yellow) for EZC100.

PE101861-33



Direct rotary handle (black) for EZC250/EZCV250.

PE102167-33



Direct rotary handle (red/yellow) for EZC250/EZCV250.

Direct rotary handle

Suitable for Motor Control Centre (MCC) switchboards.

- Degree of protection IP40 or IP54, IK07 (IP54 with gasket supplied).
- The direct rotary handle maintains:
 - suitability for isolation
 - indication of the three positions O (OFF), I (ON) and tripped
 - circuit breaker locking capability in the OFF position by one to three padlocks, (padlock not supplied) shackle diameter $\varnothing 5$ for EZC100, $\varnothing 8$ for EZC250/EZCV250
 - door opening disabled when the circuit breaker is ON
 - circuit breaker closing is disabled if the door is open.

IP40 or IP54

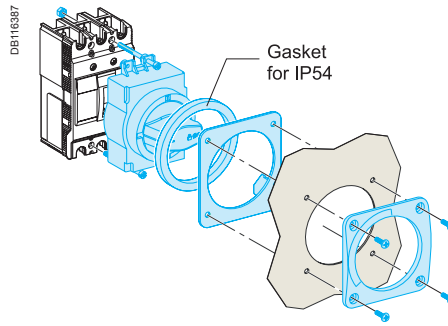

EZC100.

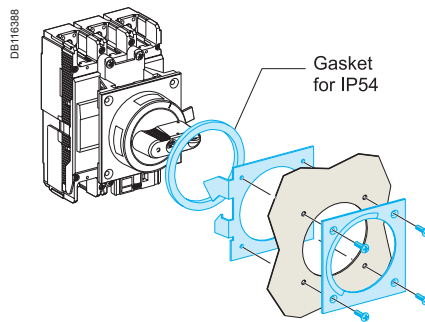

EZC250/EZCV250.

Padlocking

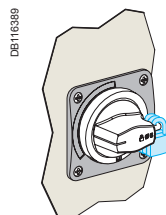

EZC100.

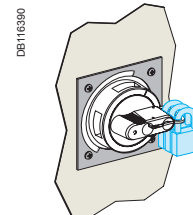

EZC250/EZCV250.

| Designation | Cat. no. | |
|-----------------------------------|------------|----------------|
| | EZC100 | EZC250/EZCV250 |
| Direct rotary handle (black) | EZAROTDS | EZEROTDS |
| Direct rotary handle (red/yellow) | EZAROTDSRY | EZEROTDSRY |

Extended rotary handle 100-250AF



Extended rotary handle (black) for Ezc100.

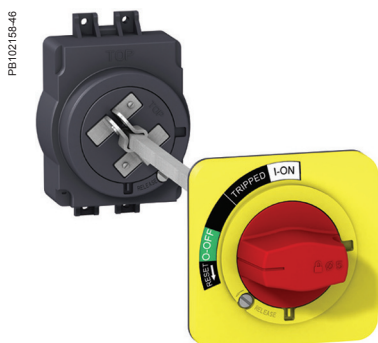

Extended rotary handle (red/yellow) for Ezc100.



Extended rotary handle (black) for Ezc250/EzcV250.

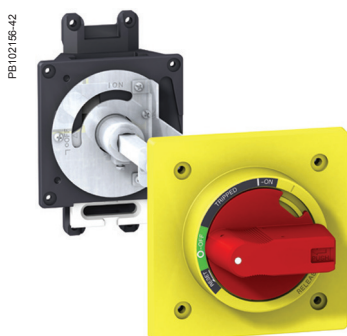

Extended rotary handle (red/yellow) for Ezc250/EzcV250.

Extended rotary handle

The extended rotary handle is used to control, from the front face of the switchboard, a device installed at the back of the switchboard.

- Degree of protection IP40 or IP54, IK08 (IP54 with gasket supplied).
- The extended rotary handle maintains:
 - suitability for isolation
 - indication of the three positions O (OFF), I (ON) and tripped
 - circuit breaker locking capability in the OFF position by one to three padlocks, (padlock not supplied) shackle diameter: Ø 5 for Ezc100, Ø 8 for Ezc250/EzcV250
 - door opening disabled when the circuit breaker is ON.
- The extended rotary handle is made up of:
 - a unit on the front cover of the circuit breaker (secured by screws)
 - an assembly (handle and front plate) on the door that is always secured in the same position, whether the circuit breaker is installed vertically or horizontally
 - an extension shaft that must be adjusted to the distance between back of circuit breaker and door.

IP40 or IP54

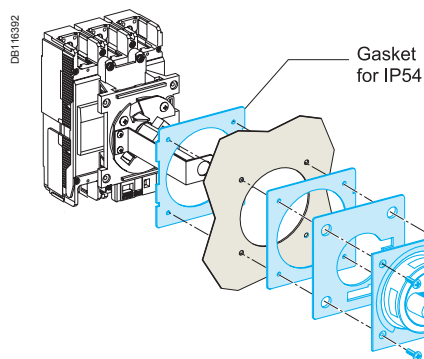
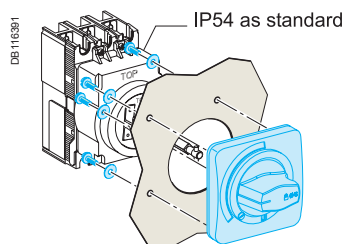

Padlocking

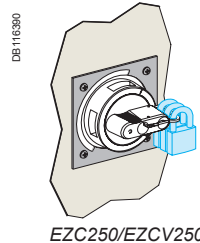
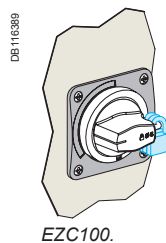

| Designation | Cat. no. | |
|-------------------------------------|-----------|----------------|
| Extended rotary handle (black) | Ezc100 | Ezc250/EzcV250 |
| Extended rotary handle (red/yellow) | EZAROTE | EZEROTE |
| | EZAROTERY | EZEROTERY |

Functions and characteristics

Plug-in 100 A

The plug-in allows you to connect, disconnect from the circuit breaker rapidly.



Plug-in

The plug-in base is equipped with terminals which, depending on their orientation, serve for front and rear connection. Degree of protection IP20.

DB127455

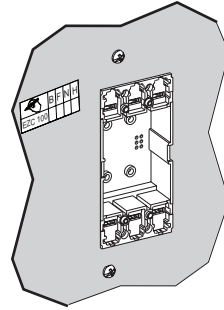

Front connection.

DB127456

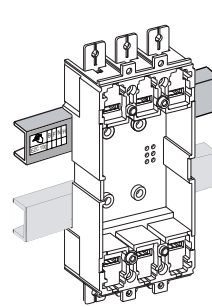

Fixation on rail DIN.

DB127457

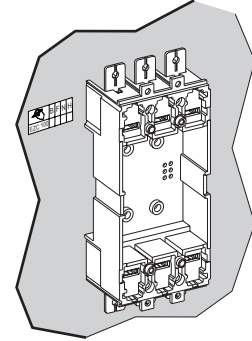

Fixation on rear plate.

Connection accessories

All accessories for fixed devices (bars, lugs) may be used with the plug-in base.

DB127458

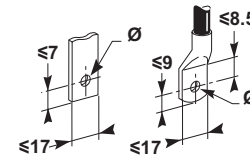
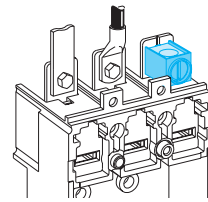

Tightening torque

PB106398-30



PB106398-33



EZAPCON1L



EZAPCON1H

PB106397-27

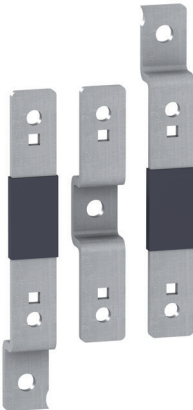

EZAFSHB3

CPB100609



Fishbone.

References Plug-in

100 A

| | |
|----------------------|---------------------------------|
| EZAPLUG3L | Kit, plug-in base 3P 15 A-50 A |
| EZAPLUG3H | Kit, plug-in base 3P 60 A-100 A |
| EZAFSHB3 - set of 3 | Fishbone connectors |
| EZAPCON1L - set of 2 | Plug-in connectors 15 A-50 A |
| EZAPCON1H | Plug-in connectors 60 A-100 A |

Fishbone

The fishbone, designed for vertical installation, saves space and reduces cabling time.

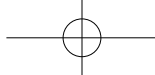

Insulation of live parts

Short terminal shield only.

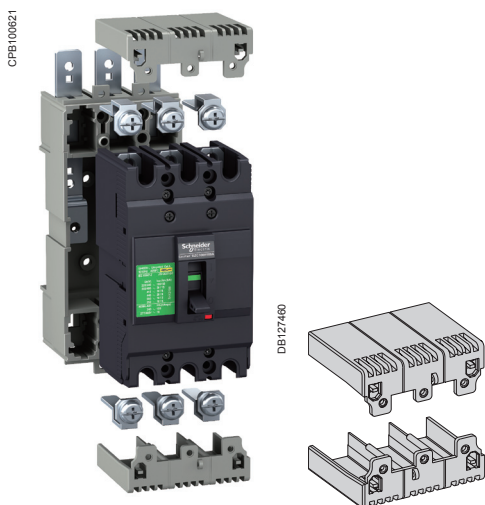

Terminal shields

Insulating accessories used for protection against direct contact with power circuits. They provide IP40 degree of protection and IK07 mechanical impact protection.

Terminal-shield types

Easypact EVC 100 to 250:

- short terminal shields

Short terminal shields

They are used with:

- plug-in in all connection configurations
- fixed versions with rear connection.

Terminal shields and pitch

Combination possibilities are shown below.

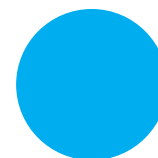

| Circuit breaker Easypact EVC | 100/160/250 |
|------------------------------|-------------|
| Pitch (mm) | 35 |

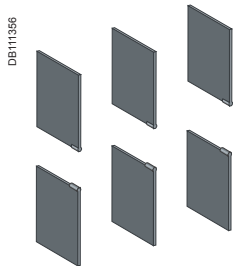

Interphase barriers

Safety accessories for maximum insulation at the power-connection points:

- they clip easily onto the circuit breaker
- single version for fixed devices and adapters on plug-in bases
- not compatible with terminal shields
- the adapter for the plug-in base is required for mounting on plug-in and withdrawable versions.

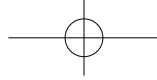

Functions and characteristics

Plug-in 250 A

The plug-in allows you to connect, disconnect from the circuit breaker rapidly.

Plug-in

The plug-in base is equipped with terminals which, depending on their orientation, serve for front and rear connection. Degree of protection IP20.

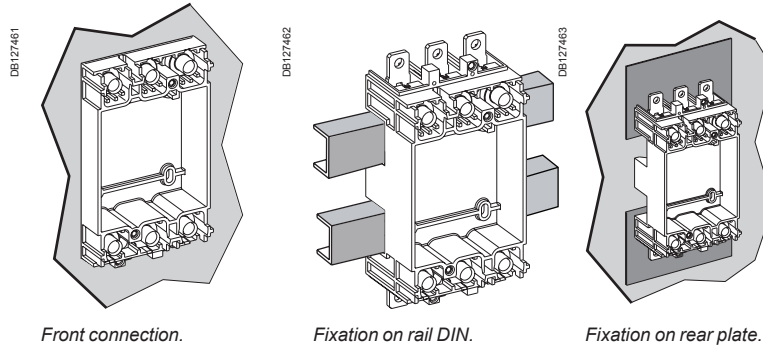

Front connection.

Fixation on rail DIN.

Fixation on rear plate.

Connection accessories

All accessories for fixed devices (bars, lugs).

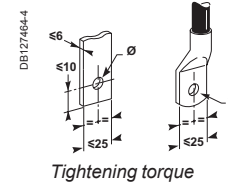
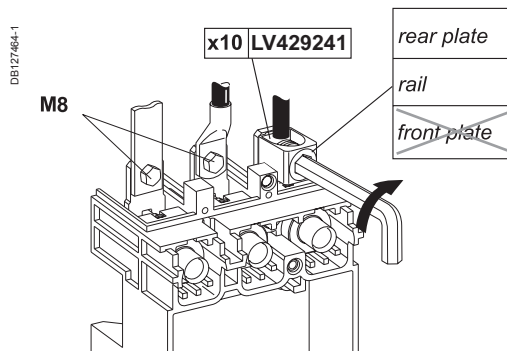

EZEPCON1

| References Plug-in | 250 A |
|---------------------------|---------------------------------------|
| EZEPLUG3L - 60 mm breaker | Kit, plug-in base 3P 100 A - 250 A |
| EZEPLUG3H - 68 mm breaker | Kit, plug-in base 3P 100 A - 250 A |
| EZEPLUG4 - 68 mm breaker | Kit, plug-in base 4P 100 A - 250 A |
| EZEPCON1 - set of 2 | Kit, plug-in connectors 100 A - 250 A |

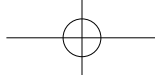

Insulation of live parts

Short terminal shield only



Terminal shields

Insulating accessories used for protection against direct contact with power circuits. They provide IP40 degree of protection and IK07 mechanical impact protection.

Terminal-shield types

Easypact EZC 100 to 250:

- short terminal shields.

Short terminal shields

They are used with:

- plug-in in all connection configurations
- fixed versions with rear connection.

Terminal shields and pitch

Combination possibilities are shown below.

| Circuit breaker Easypact | 100/160/250 |
|--------------------------|-------------|
| Short terminal shields | |
| Pitch (mm) | 35 |

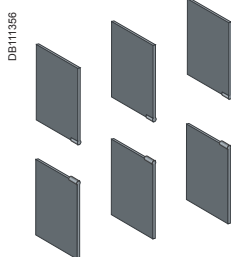
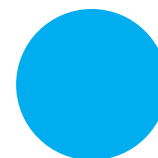

Interphase barriers.

Interphase barriers

Safety accessories for maximum insulation at the power-connection points:

- they clip easily onto the circuit breaker
- single version for fixed devices and adapters on plug-in bases
- not compatible with terminal shields
- the adapter for the plug-in base is required for mounting on plug-in and withdrawable versions.

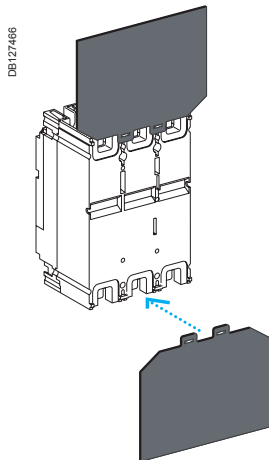

Rear insulating screens.

Rear insulating screens

Safety accessories providing insulation at the rear of the device.

Their use is mandatory for devices with spreaders, installed on backplates, when terminal shields are not used.

The available screen dimensions are shown below.

| Circuit breaker Easypact | 100/160/250 | |
|--------------------------|------------------------|---------------|
| 3P | W x H x thickness (mm) | 140 x 105 x 1 |
| 4P | W x H x thickness (mm) | 175 x 105 x 1 |

Power connections and cable lugs 100-250AF

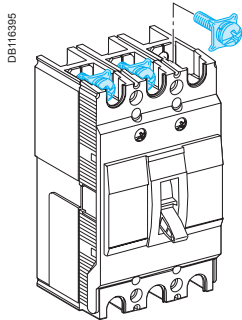

Standard circuit breaker terminals

All EasyPact EZC circuit breakers are supplied with terminal screws

EZC100 15 to 50 A Screw M5

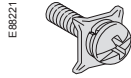

EZC100 60 to 100 A Screw M8

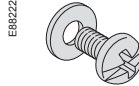

EZC250/EZCV250 63 to 250 A Screw M8

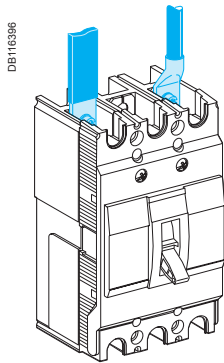
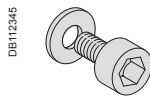

Connection of insulated bars or cables with lugs

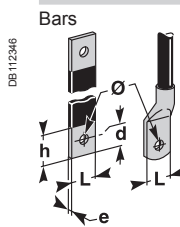

| | EZC100 | EZC250/ EZCV250 |
|--------|--------|--------------------|
| Bars | | |
| L (mm) | ≤ 17 | ≤ 25 |
| h (mm) | d + 10 | d + 10 |
| d (mm) | ≤ 7 | ≤ 8 |
| e (mm) | ≤ 6 | ≤ 6 |
| Ø (mm) | ≤ 50 A | 5.5 |
| | > 50 A | 8.5 |
| | | 9 |

| | | | |
|-------------------|--------|---------|--------|
| Crimp lugs | L (mm) | ≤ 17 | ≤ 25 |
| | d (mm) | ≤ 9 | ≤ 8 |
| | Ø (mm) | ≤ 50 A | 5.5 |
| | | > 50 A | 8.5 |
| Tightening torque | ≤ 50 A | 2 N.m | - |
| | > 50 A | 5.5 N.m | 13 N.m |

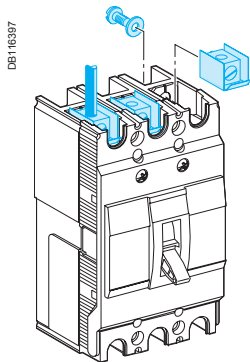

Cable lugs

Cable lugs directly screwed on standard circuit breaker terminals.

≤ 50 A (EZC100) > 50 A (EZC100) ≥ 100 A (EZC250/EZCV250)

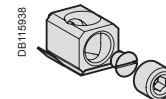
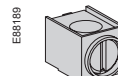
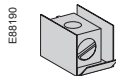

Cables from 2.5 to 16 mm².

Cables from 10 to 50 mm².

Cables from 42.2 to 150 mm².

| Designation | Cat. no. | |
|---|---------------------------|----------------|
| | EZC100 | EZC250/EZCV250 |
| Cable lug up to 50 A (set of 2) | EZALUG0502 ⁽¹⁾ | - |
| Cable lug up to 50 A (set of 3) | EZALUG0503 ⁽¹⁾ | - |
| Cable lug from 60 A up to 100 A (set of 2) | EZALUG1002 ⁽²⁾ | - |
| Cable lug from 60 A up to 100 A (set of 3) | EZALUG1003 ⁽²⁾ | - |
| Cable lug from 100 A up to 250 A (set of 3) | - | EZELUG2503 |
| Cable lug from 100 A up to 250 A (set of 4) | - | EZELUG2504 |

Important:

(1) EZALUG0502 and EZALUG0503 can be use with maximum rating of 50 A.

(2) EZALUG1002 and EZALUG1003 can be use with maximum rating of 100 A.

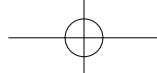

Power connections and insulation of live parts 100-250AF

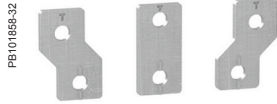

Spreader.

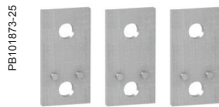

Terminal extensions.

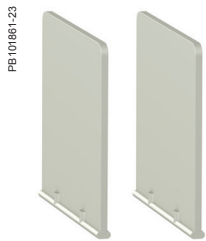

Phase barriers for Ezc100.



Phase barriers for Ezc250/
EzcV250.

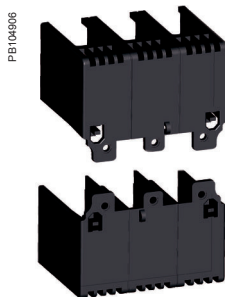

Terminal shield for Ezc100.

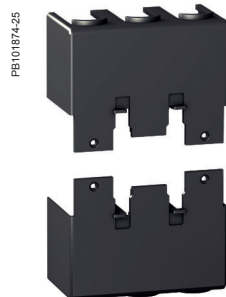

Terminal shield
for Ezc250/EzcV250.

Spreaders

Increase the pitch of the circuit breaker terminals:

- Ezc100 from 25 mm to 35 mm
- Ezc250/EzcV250 from 35 mm to 45 mm.

Terminal extensions

Additional terminal extensions are available for Ezc250/EzcV250 at 35 mm pitch.

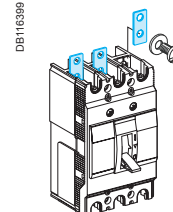
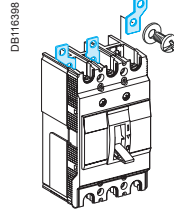

| Designation | Cat. no. | |
|--|-----------|----------------|
| | Ezc100 | Ezc250/EzcV250 |
| Spreaders for 3-pole breaker (set of 3) | EZASPDR3P | EZESPDR3P |
| Spreaders for 4-pole breaker (set of 4) | EZASPDR4P | EZESPDR4P |
| Terminal extension for 3-pole breaker (set of 3) | - | EZETEX |
| Terminal extension for 4-pole breaker (set of 4) | - | EZETEX4P |

Phase barriers

- Safety accessories for maximum insulation at the power connection points.
- Usable with all other connection accessories, except terminal shields.
- Each breaker is delivered with a set of phase barriers (1 for 2 poles, 2 for 3 poles and 3 for 4 poles breaker).
- Additional set of phase barriers available for insulation between outgoing or between 2 side by side mounted breakers.

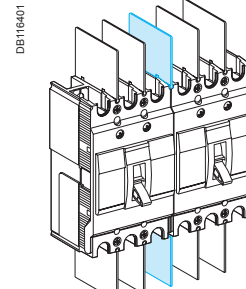
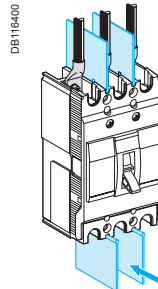

| Designation | Cat. no. | |
|---|----------|----------------|
| | Ezc100 | Ezc250/EzcV250 |
| Phase barriers for 60 mm depth (set of 2) | EZAFASB2 | EZEFASB2 |
| Phase barriers for 68 mm depth (set of 3) | - | EZEFASB3N |

Terminal shields

- Insulating accessory used for protection against direct contacts with power circuit connections. It provides a degree of protection of IP20 and a mechanical resistance of IK07.
- The long terminal shield is used with front cable or isolated busbar connections.
- Designed for 3-pole Ezc100, 3, 4-pole Ezc250/EzcV250.

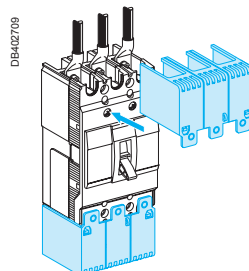

| Designation | Cat. no. | |
|--|-----------|----------------|
| | Ezc100 | Ezc250/EzcV250 |
| Terminal shield 3P, 60 mm depth (set of 2) | EZATSHD3P | EZETSHD3P |
| Terminal shield 3P, 68 mm depth (set of 2) | - | EZETSHD3PN |
| Terminal shield 4P, 60 mm depth (set of 2) | EZATSHD4P | - |
| Terminal shield 4P, 68 mm depth (set of 2) | - | EZETSHD4PN |

DIN rail adaptor, padlocking, sealing screws 100-250AF

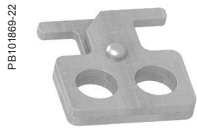

Padlocking device for
EVC100.



Padlocking device for
EVC250/EZCV250.

DIN rail adaptor

Breaker mounting on a DIN rail is possible by using special adaptor (EVC100 only).

Number of adaptators:

- one for two 1P, or one 2P or one 3P
- two for one 4P.

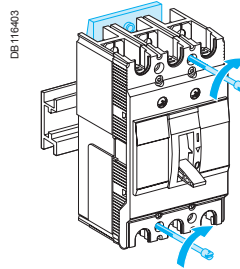

Mounting on DIN rail (optional).

| Designation | Cat. no. | |
|------------------|----------|----------------|
| | EVC100 | EVC250/EZCV250 |
| Din rail adaptor | EZADINR | - |

Padlocking system

Locking in the OFF position guarantees isolation as per IEC 60947-2.

Padlocking system can receive:

- up to 2 padlocks Ø 5 mm (padlocks not supplied) for EVC100
- up to 3 padlocks Ø 8 mm for EVC250/EZCV250 (padlocks not supplied).

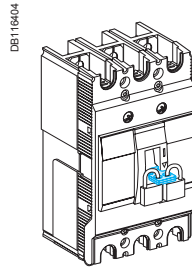

Toggle locking using a removable device:
for EVC100

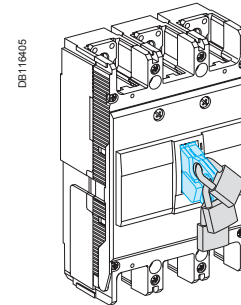

for EVC250/EZCV250

| Designation | Cat. no. | |
|---|----------|----------------|
| | EVC100 | EVC250/EZCV250 |
| Padlocking system | EZALOCK | - |
| Padlocking system for EVC250-3P | - | EZELOCK |
| Padlocking system for EVC250-4P and EZCV250-3/4P | - | EZELOCKN |

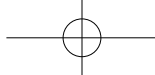

FB1101860-30



Sealing screws

DB116406

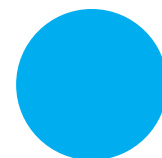
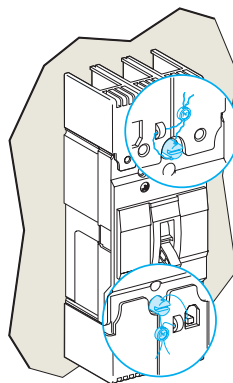

| Designation | Cat. no. | |
|---------------------------|----------|----------------|
| Sealing screws (set of 2) | EZC100 | EZC250/EZCV250 |
| | EZASSCR | - |

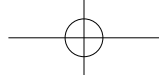

Functions and characteristics

Accessories and auxiliaries of EZC400-630

Connection of devices

Fixed circuit breakers are designed for standard front connection using bars or cables with lugs. Cable connectors are available for bare cables. Rear connection is also possible.

Front connection

Bars or cables with lugs

Standard terminals

EasyPact EZC400 to 630 come with terminals comprising snap-in nuts with screws:

- EasyPact EZC400/630: M10 nuts and screws.

These terminals may be used for:

- direct connection of insulated bars or cables with lugs
- terminal extensions.

Interphase barriers or terminal shields are recommended. They are mandatory for certain connection accessories (in which case the interphase barriers are provided).

Bars

When the switchboard configuration has not been tested, insulated bars are mandatory.

Maximum size of bars

| EasyPact EZC circuit breaker | 400/630 | |
|------------------------------|-----------------------|--------|
| Without spreaders | pitch (mm) | 45 |
| | maximum bar size (mm) | 32 x 8 |
| With spreaders | pitch (mm) | 52.5 |
| | maximum bar size (mm) | 40 x 6 |

Crimp lugs

There are two modules of lugs, for aluminium and copper cables.

Interphase barriers or long terminal shields must be used with narrow lugs. The lugs are supplied with interphase barriers.

| EasyPact EZC circuit breaker | 400/630 | |
|------------------------------|-------------------------|-------------------------------|
| Copper cables | size (mm ²) | 240, 300 |
| | crimping | hexagonal barrels or punching |
| Aluminium cables | size (mm ²) | 240, 300 |
| | crimping | hexagonal barrels |

Terminal extensions

Extensions with anti-rotation ribs can be attached to the standard terminals to provide numerous connection possibilities in little space:

- straight terminal extensions
- right-angle terminal extensions

Spreaders

Spreaders may be used to increase the pitch:

- EZC400/630: the 45 mm pitch can be increased to 52 or 70 mm.
- Bars, cable lugs or cable connectors can be attached to the ends.

Pitch (mm) depending on the type of spreader

| EasyPact EZC circuit breaker | EZC400 to 630 |
|------------------------------|---------------|
| Without spreaders | 45 |
| With spreaders | 52.5 or 70 |

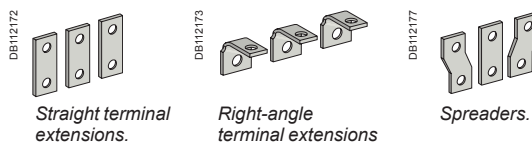
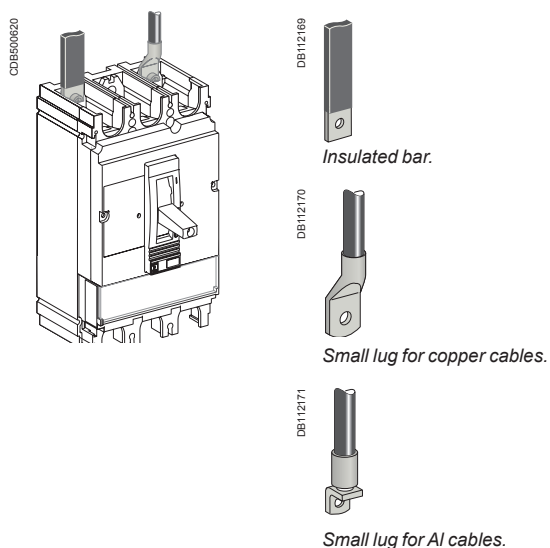

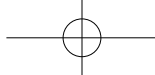

Accessories and auxiliaries of EZC400-630

Connection of devices

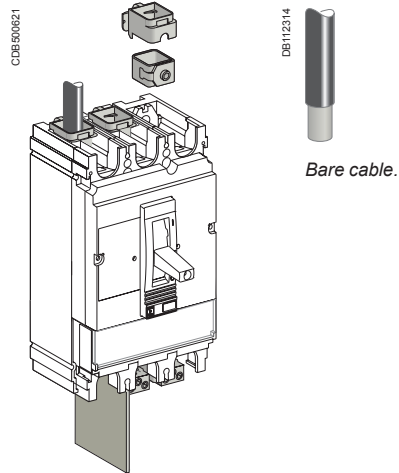

DB112314

Bare cable.

Bare cables

Bare-cable connectors may be used for both copper and aluminium cables.

1-cable connectors for EasyPact EZC400 to 630

The connectors are screwed directly to the device terminals.

Maximum size of cables depending on the type of connector

| EasyPact EZC circuit breaker | 400 | 630 |
|------------------------------|------------------------------------|-----|
| Aluminium connectors | 2 cables 35 to 240 mm ² | ■ |
| | 35 to 300 mm ² | ■ |



1-cable
connector for
EZC400/630.

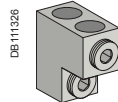

2-cable
connector for
EZC400/630.

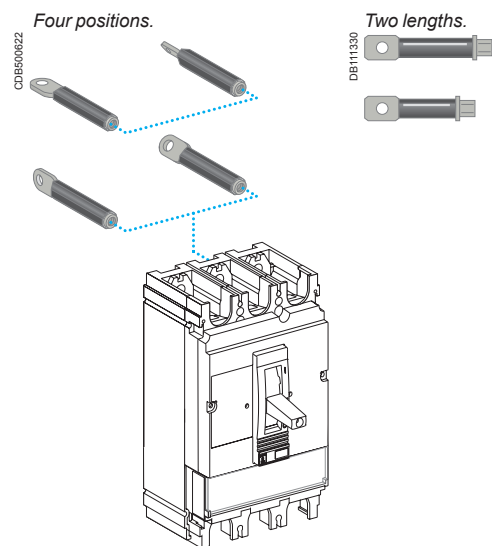

Four positions.

Two lengths.

DB11330

Rear connection

Device mounting on a backplate with suitable holes enables rear connection.

Bars or cables with lugs

Rear connections for bars or cables with lugs are available in two lengths. Bars may be positioned flat, on edge or at 45° angles depending on how the rear connections are positioned.

The rear connections are simply fitted to the device connection terminals. All combinations of rear connection lengths and positions are possible on a given device.

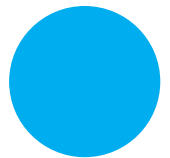

Accessories and auxiliaries of EZC400-630

Selection of auxiliaries

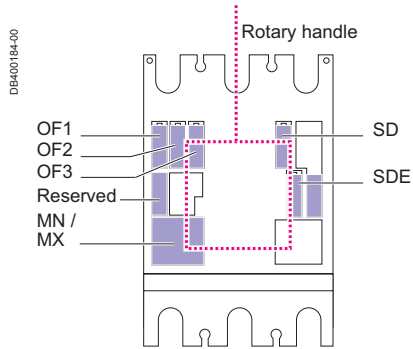

EasyPact EZC400/630

Standard

All EasyPact EZC400/630 circuit breakers and switch-disconnectors have slots for the electrical auxiliaries listed below.

5 indication contacts

- 3 ON/OFF (OF3)
- 1 trip indication (SD)
- 1 fault-trip indication (SDE)

1 remote-tripping release

- either 1 MN undervoltage release
- or 1 MX shunt release.

All these auxiliaries can be installed with a rotary handle.

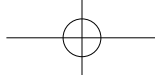

Accessories and auxiliaries of EZC400-630

Indication contacts

One contact model provides circuit-breaker status indications (OF - SD - SDE).

These common-point changeover contacts provide remote circuit-breaker status information.

They can be used for indications, electrical locking, relaying, etc. They comply with the IEC 60947-5 international recommendation.

Functions

Breaker-status indications, during normal operation or after a fault

A single type of contact provides all the different indication functions:

- OF (ON/OFF) indicates the position of the circuit breaker contacts
- SD (trip indication) indicates that the circuit breaker has tripped due to:
 - an overload
 - a short-circuit
 - an earth fault (Vigi)
 - operation of a voltage release
 - operation of the "push to trip" button
 - disconnection when the device is ON.

The SD contact returns to de-energised state when the circuit breaker is reset.

- SDE (fault-trip indication) indicates that the circuit breaker has tripped due to:
 - an overload
 - a short-circuit



Indication contacts.

Installation

■ OF, SD, SDE functions: a single type of contact provides all these different indication functions, depending on where it is inserted in the device. The contacts clip into slots behind the front cover of the circuit breaker.

Electrical characteristics of auxiliary contacts

| Contacts | | Standard | | | | Low level | | | |
|----------------------------------|--------------|-------------------|------|------|------|----------------|------|------|------|
| Types of contacts | | All | | | | OF, SD, SDE | | | |
| Rated thermal current (A) | | 6 | | | | 5 | | | |
| Minimum load | | 100 mA at 24 V DC | | | | 1 mA at 4 V DC | | | |
| Utilisation cat. (IEC 60947-5-1) | | AC12 | AC15 | DC12 | DC14 | AC12 | AC15 | DC12 | DC14 |
| Operational current (A) | 24 V AC/DC | 6 | 6 | 6 | 1 | 5 | 3 | 5 | 1 |
| | 48 V AC/DC | 6 | 6 | 2.5 | 0.2 | 5 | 3 | 2.5 | 0.2 |
| | 110 V AC/DC | 6 | 5 | 0.6 | 0.05 | 5 | 2.5 | 0.6 | 0.05 |
| | 220/240 V AC | 6 | 4 | - | - | 5 | 2 | - | - |
| | 250 V DC | - | - | 0.3 | 0.03 | 5 | - | 0.3 | 0.03 |
| 380/440 V AC | 6 | 2 | - | - | 5 | 1.5 | - | - | |

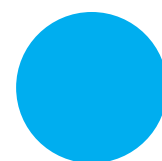

Accessories and auxiliaries of EZC400-630 Remote tripping



MX or MN voltage release.

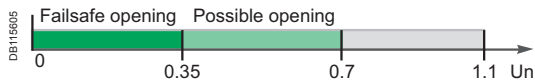

Opening conditions of the MN release.



Closing conditions of the MN release.



MN release with a time-delay unit.

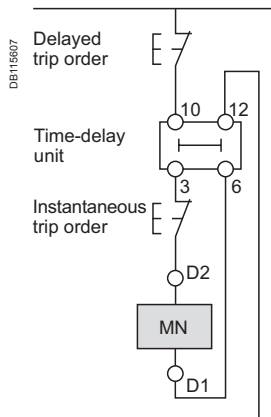

Wiring diagram for emergency-off function with MN + time-delay unit.

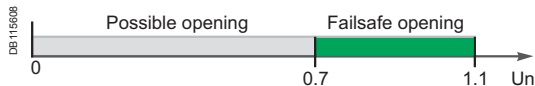

Opening conditions of the MX release.

MN undervoltage release

- This release trips the circuit breaker when the control voltage drops below a tripping threshold
- The tripping threshold is between 0.35 and 0.7 times the rated voltage
- Circuit breaker closing is possible only if the voltage exceeds 0.85 times the rated voltage.

Characteristics

| | | |
|-----------------------|---------|---------------------------------------|
| Power supply | V AC | 50/60 Hz: 24 - 48 - 100/130 - 200/240 |
| | | 50 Hz: 380/415 60 Hz: 208/277 |
| Operating threshold | V DC | 12 - 24 - 30 - 48 - 60 - 125 - 250 |
| | Opening | 0.35 to 0.7 Un |
| | Closing | 0.85 Un |
| Operating range | | 0.85 to 1.1 Un |
| Consumption (VA or W) | | Pick-up: 10 - Hold: 5 |
| Response time (ms) | | 50 |

Time-delay unit for an MN release

A time delay unit for the MN release eliminates the risk of nuisance tripping due to a transient voltage dip lasting ≤ 200 ms. For shorter micro-outages, a system of capacitors provides temporary supply to the MN at $U > 0.7$ to ensure non tripping. The correspondence between MN releases and time-delay units is shown below.

| Power supply | Corresponding MN release |
|--|--------------------------|
| Unit with fixed delay 200 ms | |
| 48 V AC | 48 V DC |
| 220 / 240 V AC | 250 V DC |
| Unit with adjustable delay (0.5s, 0.9s, 1.5s, 3s) | |
| 48 - 60 V AC/DC | 48 V DC |
| 100 - 130 V AC/DC | 125 V DC |
| 220 - 250 V AC/DC | 250 V DC |

MX shunt release

The MX release opens the circuit breaker via an impulse-type (≥ 20 ms) or maintained order.

Opening conditions

When the MX release is supplied, it automatically opens the circuit breaker. Opening is ensured for a voltage $U \geq 0.7 \times U_n$.

Characteristics

| | | |
|-----------------------|------|---------------------------------------|
| Power supply | V AC | 50/60 Hz: 24 - 48 - 100/130 - 200/240 |
| | | 50 Hz: 380/415 60 Hz: 208/277 |
| | V DC | 12 - 24 - 30 - 48 - 60 - 125 - 250 |
| Operating range | | 0.7 to 1.1 Un |
| Consumption (VA or W) | | Pick-up: 10 |
| Response time (ms) | | 50 |

Circuit breaker control by MN or MX

When the circuit breaker has been tripped by an MN or MX release, it must be reset before it can be reclosed.

MN or MX tripping takes priority over manual closing.

In the presence of a standing trip order, closing of the contacts, even temporary, is not possible.

Connection using wires up to 1.5mm² to integrated terminal blocks.

Note: circuit breaker opening using an MN or MX release must be reserved for safety functions. This type of tripping increases wear on the opening mechanism. Repeated use reduces the mechanical endurance of the circuit breaker by 50 %.



Accessories and auxiliaries of EZC400-630

Rotary handles escutcheons and protection collars

There are two types of rotary handle:

- direct rotary handle
- extended rotary handle.



EasyPact EZC400 with a rotary handle.

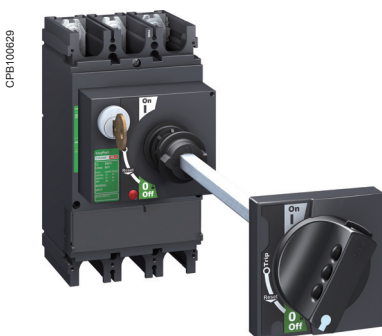

EasyPact EZC400 with an extended rotary handle installed at the back of a switchboard, with the keylock option and key.



Escutcheons are an optional feature mounted on the switchboard door. They increase the degree of protection to IP40, IK07. Protection collars maintain the degree of protection, whatever the position of the device (connected, disconnected).

Direct rotary handle

Standard handle

Degree of protection IP40, IK07.

The direct rotary handle maintains:

- visibility of and access to trip-unit settings
- suitability for isolation
- indication of the three positions O (OFF), I (ON) and tripped
- access to the "push to trip" button.

Device locking

The rotary handle facilitates circuit-breaker locking.

- Padlocking:
 - standard situation, in the OFF position, using 1 to 3 padlocks, shackle diameter 5 to 8 mm, not supplied

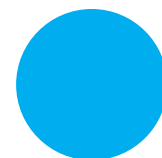

Extended rotary handle

Degree of protection IP56, IK08.

The extended rotary handle makes it possible to operate circuit breakers installed at the back of switchboards, from the switchboard front.

It maintains:

- visibility of and access to trip-unit settings
- suitability for isolation
- indication of the three positions O (OFF), I (ON) and tripped.

Device and door padlocking

Padlocking locks the circuit-breaker handle and disables door opening:

- standard situation, in the OFF position, using 1 to 3 padlocks, shackle diameter 5 to 8 mm, not supplied

Parts of the extended rotary handles

- A unit that replaces the front cover of the circuit breaker (secured by screws).
- An assembly (handle and front plate) on the door that is always secured in the same position, whether the circuit breaker is installed vertically or horizontally.
- An extension shaft that must be adjusted to the distance. The min/max distance between the back of circuit breaker and door is:
 - 209...600 mm for EasyPact EZC 400/630.

Manual source-changeover systems

An additional accessory interlocks two devices with rotary handles to create a source-changeover system. Closing of one device is possible only if the second is open.

This function is compatible with direct or extended rotary handles. Up to three padlocks can be used to lock in the OFF or ON position.

IP40 escutcheons for fixed devices

There are three types of escutcheon with a gasket which are screwed to the door cut-out:

- three escutcheons for all control types (toggle, handle or motor mechanism)
- a wide model for Vigi modules that can be combined with the above.

Accessories and auxiliaries of EZC400-630

Locks and sealing accessories

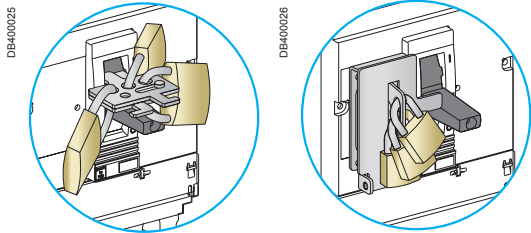

Toggle locking using padlocks and an accessory:
Removable device Fixed device attached to the case.

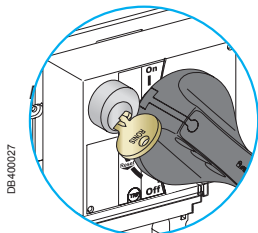

Rotary-handle locking using a keylock.

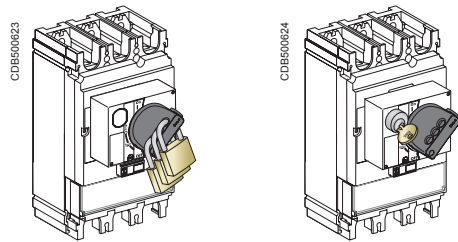

Rotary-handle locking using a padlock or a keylock.

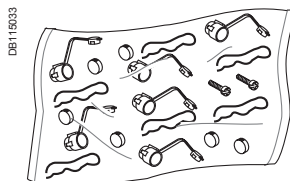

Sealing accessories.

Locks

Locking in the OFF position guarantees isolation as per IEC 60947-2. Padlocking systems can receive up to three padlocks with shackle diameters ranging from 5 to 8 mm (padlocks not supplied). Certain locking systems require an additional accessory.

| Control device | Function | Means | Required accessories |
|------------------------|--|---------|--------------------------|
| Toggle | Lock in OFF position | Padlock | Removable device |
| | Lock in OFF or ON position | Padlock | Fixed device |
| Direct rotary handle | Lock in OFF position | Padlock | - |
| | OFF or ON position ⁽¹⁾ | Keylock | Locking device + keylock |
| Extended rotary handle | Lock in OFF position | Padlock | - |
| | OFF or ON position ⁽¹⁾ with door opening prevented ⁽²⁾ | Padlock | - |
| | Lock in OFF position | Padlock | UL508 control accessory |
| | OFF or ON position ⁽¹⁾ inside the switchboard | Keylock | Locking device + keylock |

⁽¹⁾ Following a simple modification of the mechanism.
⁽²⁾ Unless door locking has been voluntarily disabled.

Sealing accessories

Toggle control

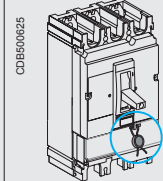

Rotary handle

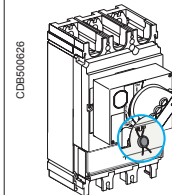

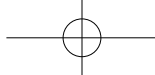

EasyPact EZC

Busbars

| | |
|--|------------|
| <i>Presentation</i> | <i>II</i> |
| <i>Functions and characteristics</i> | <i>A-1</i> |
| Introduction | B-2 |
| Busbars characteristics | B-4 |
| Main busbars and extension | B-5 |
| Accessories | B-6 |
| Dimensions | |
| Busbar EZB250 | B-7 |
| Busbars EZB400/630 | B-8 |
| EasyPact EZC or Compact NSX branch extensions layout | B-9 |
| <i>Installation guide</i> | <i>C-1</i> |
| <i>Catalogue numbers</i> | <i>D-1</i> |

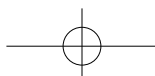
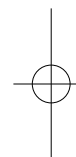
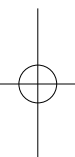
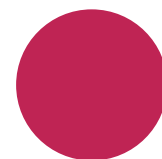

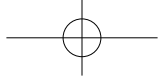

Busbars

Introduction

DB116419.eps

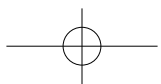
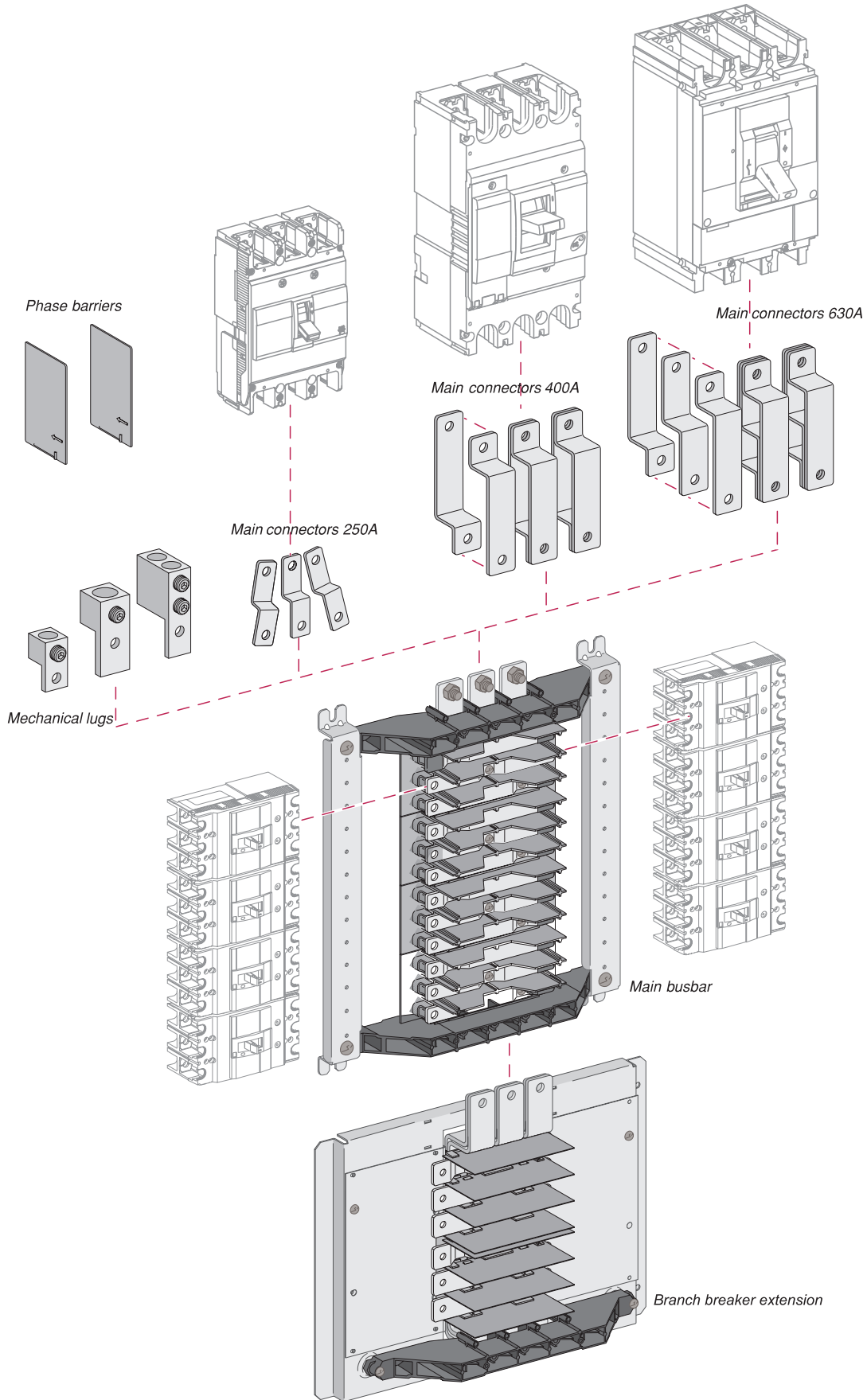

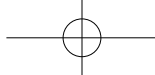

The EasyPact EZC Busbar - engineered and certified together with the EasyPact EZC MCCB to provide superior performance, flexibility and value. Simply the best solution for your distribution panel needs:

- available for 250 A, 400 A or 630 A main incoming current
- available for 4, 6, 8, 10 or 12 Ways (3 poles) EasyPact EZC 100 A (max.) outgoing MCCB's
- 400 A and 630 A systems can accept an additional 2 or 4 EasyPact EZC 250 or Compact NSX250 outgoing MCCB's
- designed and tested to meet IEC 60439-1 requirements
- completely assembled in ISO certified facility for easy installation into locally made enclosures.

CFB 100623

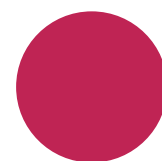
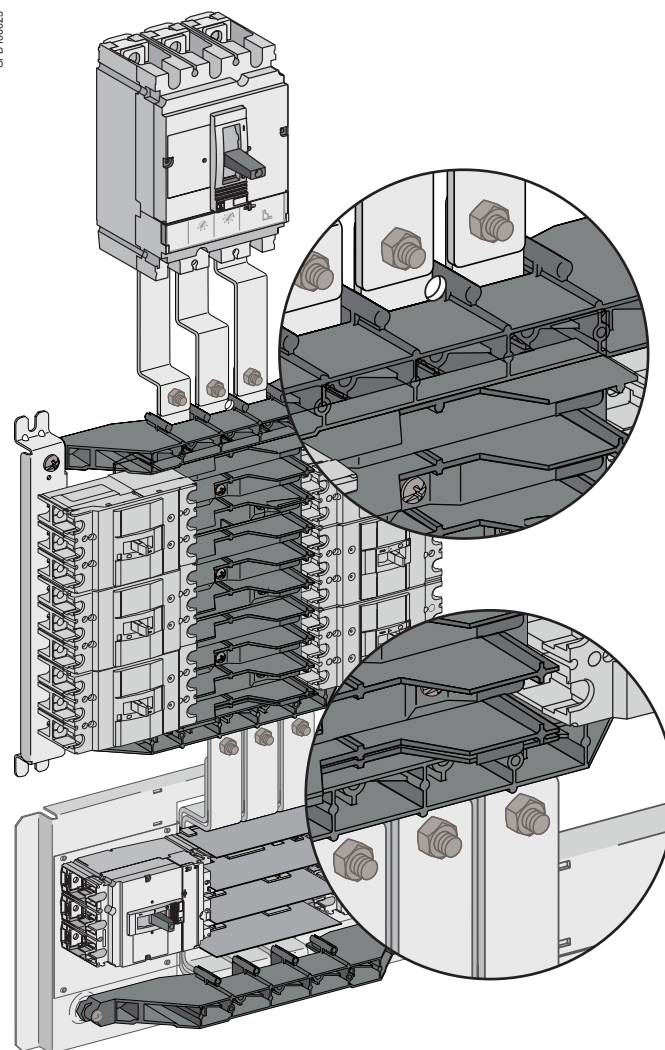

Premium Materials make a premium busbar system

- Solid copper busbars and connectors for cool, care-free operation.
- Electro-tin plating on all busbars and connectors for corrosion resistance in all environments.
- Fiberglass reinforced nylon bus supports for strength and dimensional stability.
- Molded thermoplastic phase barriers to maintain alignment and ensure electrical isolation between phases.

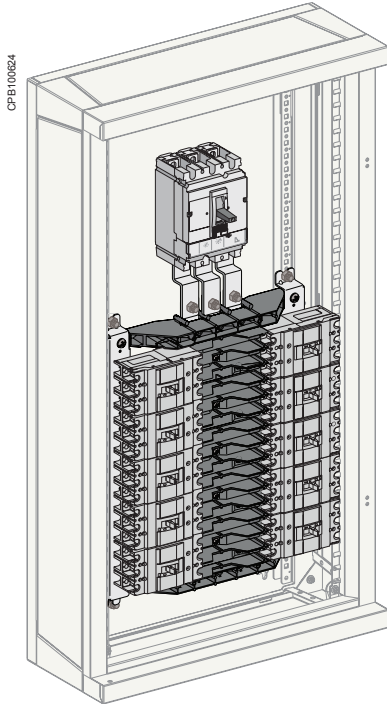

Enclosed 10 ways Busbar 250 A with 250 A main incomer.

Compliance with standards

The EasyPact EZC Busbar System is designed and certified to meet all international requirements specified in IEC 60439-1 relating to construction of Low Voltage switchgear and controlgear assemblies, including:

- verification of temperature - rise limits
- verification of dielectric properties
- verification of short-circuit withstand strength
- verification of clearances and creepage distances.

In addition, the system has been type-tested in ASTA labs to confirm the short-circuit and short-time withstand ratings.

| EasyPact EZC Busbar System | | EZB250 | | | | | EZB400 | | | | | EZB630 | | | | |
|--|---------|---|----|----|----|----|-------------------|----|----|----|----|-------------------|----|----|----|----|
| Number of ways | | 4 | 6 | 8 | 10 | 12 | 4 | 6 | 8 | 10 | 12 | 4 | 6 | 8 | 10 | 12 |
| Numbers of outgoing (EasyPact EZC 100) | 1P | 12 | 18 | 24 | 30 | 36 | 12 | 18 | 24 | 30 | 36 | 12 | 18 | 24 | 30 | 36 |
| | 2P | 6 | 8 | 12 | 14 | 18 | 6 | 8 | 12 | 14 | 18 | 6 | 8 | 12 | 14 | 18 |
| | 3P | 4 | 6 | 8 | 10 | 12 | 4 | 6 | 8 | 10 | 12 | 4 | 6 | 8 | 10 | 12 |
| Extension for EZ/NSX breakers | | No extension | | | | | Yes (2 or 4 Ways) | | | | | Yes (2 or 4 Ways) | | | | |
| Electrical characteristics | | | | | | | | | | | | | | | | |
| Rated incoming current (A) | | 250 | | | | | 400 | | | | | 630 | | | | |
| Rated operational voltage (V) AC 50/60 Hz | | 550 | | | | | 550 | | | | | 550 | | | | |
| Rated insulation voltage (V) | | 690 | | | | | 690 | | | | | 690 | | | | |
| Breaking capacity | | Refer to cascading tables page C-18 | | | | | | | | | | | | | | |
| Rated short-time withstand current (kA rms) 1 sec. | | 30 | | | | | 40 | | | | | 40 | | | | |
| Dimensions | | | | | | | | | | | | | | | | |
| Dimensions H x W x D (mm) | 4 Ways | 268.5 x 416 x 82.5 | | | | | 290 x 416 x 107 | | | | | 290 x 416 x 107 | | | | |
| | 6 Ways | 343.5 x 416 x 82.5 | | | | | 365 x 416 x 107 | | | | | 365 x 416 x 107 | | | | |
| | 8 Ways | 418.5 x 416 x 82.5 | | | | | 440 x 416 x 107 | | | | | 440 x 416 x 107 | | | | |
| | 10 Ways | 493.5 x 416 x 82.5 | | | | | 515 x 416 x 107 | | | | | 515 x 416 x 107 | | | | |
| | 12 Ways | 568.5 x 416 x 82.5 | | | | | 590 x 416 x 107 | | | | | 590 x 416 x 107 | | | | |

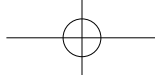

Main busbars and extension

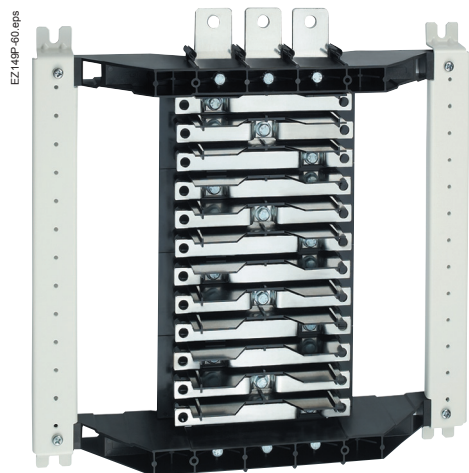

EasyPact Ezc Busbar EZB250W08.

Main busbar

The core of the EasyPact Ezc Busbar System includes the main busbars and outgoing connectors for EasyPact Ezc MCCB's.

| Designation | Cat. no. | | |
|----------------------------|-----------|-----------|-----------|
| Type | EZB250 | EZB 400 | EZB630 |
| Main busbar current rating | 250 A | 400 A | 630 A |
| Number of ways | | | |
| 4 ways | EZB250W04 | EZB400W04 | EZB630W04 |
| 6 ways | EZB250W06 | EZB400W06 | EZB630W06 |
| 8 ways | EZB250W08 | EZB400W08 | EZB630W08 |
| 10 ways | EZB250W10 | EZB400W10 | EZB630W10 |
| 12 ways | EZB250W12 | EZB400W12 | EZB630W12 |

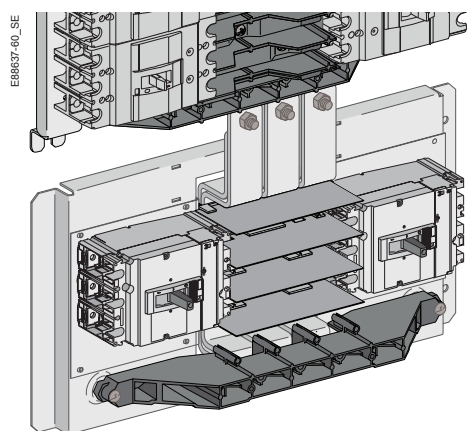
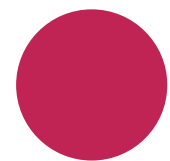
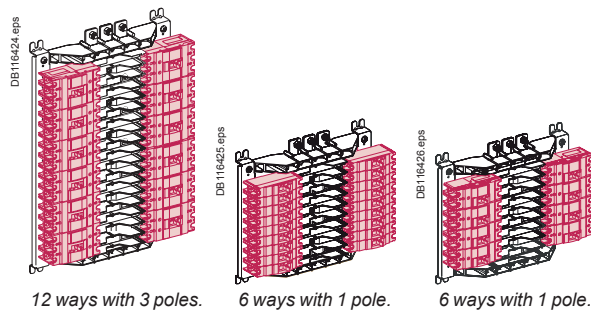
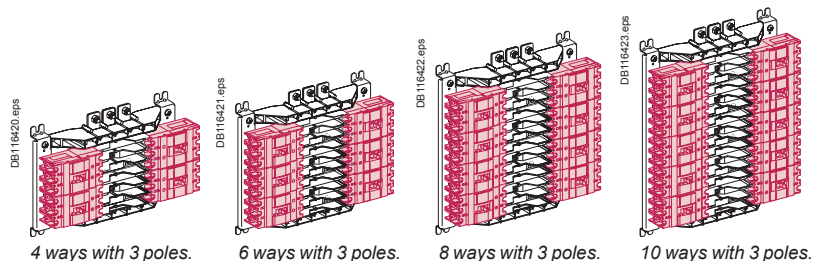

EasyPact Ezc and Compact NSX branch breaker extension 2 ways.

EasyPact Ezc and Compact NSX branch extension

For applications calling for larger than 100 A outgoing MCCB's, EasyPact Ezc Busbar rated 400 A and 630 A can accept the 2 ways or 4 ways EasyPact Ezc and Compact NSX branch extension for up to four additional 250 A max. outgoing circuits. EasyPact Ezc and Compact NSX branch extensions simply connect directly to the terminals provided on the EZB400 and EZB630 EasyPact Ezc Busbar.

| Designation | Cat. no. |
|------------------------------------|----------|
| EZ/NSX/NB branch breaker extension | |
| 2 ways | EZBNS2 |
| 4 ways | EZBNS4 |

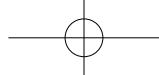

Busbars

Accessories

E88301-50.eps



Main incoming connections

Incoming cables with crimped lugs can connect directly to the terminals provided.

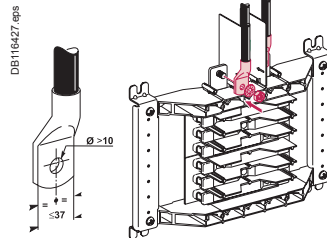

EZ117P-60_SE

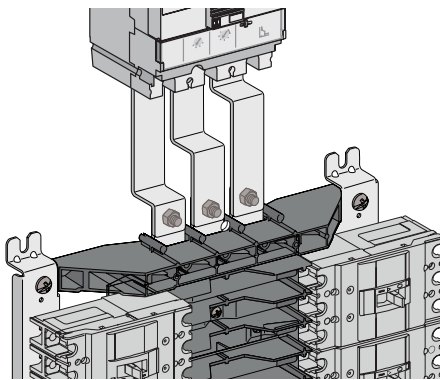

Main connectors

For installing a main disconnect device (EasyPact EZC or Compact NSX MCCB or INS switch) ahead of EasyPact EZC Busbar, use the tin-plated copper connector kits below.

| Designation | Cat. no. | | |
|--|------------|------------|------------|
| Main Busbar current rating | 250 A | 400 A | 630 A |
| Main disconnect device for EasyPact EZC or Compact NSX or INS switch | EZB250MCNS | EZB400MCNS | EZB630MCNS |

C0B500620_00

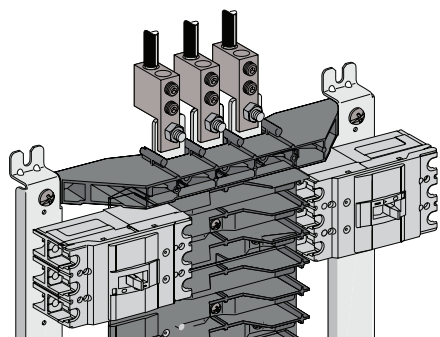

Mechanical lugs

For incoming cables without crimped lugs, use the mechanical lug kits below. Each kit contains three aluminium lugs suitable for copper or aluminium cables.

| Designation | Cat. no. | | |
|----------------------------|------------------------|-----------------------|--|
| Main Busbar current rating | 250 A | 400 A | 630 A |
| Incoming cable size | 16-150 mm ² | 35-300mm ² | 25-240 mm ² 2 cables per phase |
| Lug kit | EZB250MLUG | EZB400MLUG | EZB630MLUG |

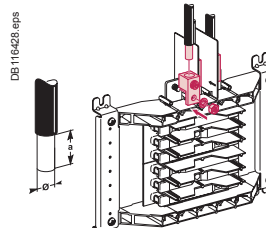

| | A | B | C |
|-------|------------------------|------------------------|-------|
| 250 A | | | |
| a | Ø | Ø | Ø |
| A | 26 | 16-150 mm ² | 31 Nm |
| B | 35 | 35-300 mm ² | 56 Nm |
| C | 30 | 25-240 mm ² | 56 Nm |
| 60 | 25-240 mm ² | 56 Nm | |

E88010-54_SE

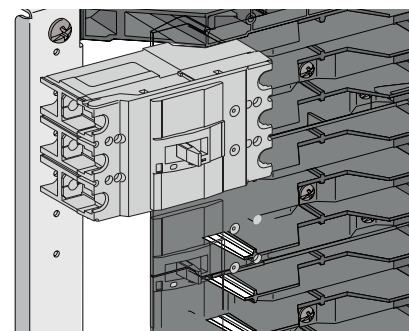

Connector caps

Connector caps are available to isolate the ends of connectors in positions where branch breakers are not installed.

Mounting screws are provided for an insulating barrier (locally provided) to cover the branch connectors when IP2X finger safety is specified.

| Designation | Cat. no. |
|---------------------------|-----------|
| Connector caps (set of 3) | |
| Caps for 100 A outgoing | EZB100CAP |
| Caps for 250 A outgoing | EZB250CAP |

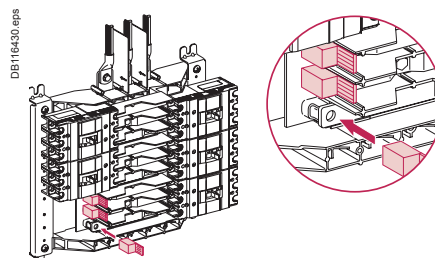



Dimensions

Busbar EZB250

Layout installation EZB250

Panel layout using the EasyPact EZC Busbar is simple using the guides below. In addition to the mounting locations for the busbar and main disconnect components (if required), make note of the minimum clearances required to the top, bottom and sides of the enclosure.

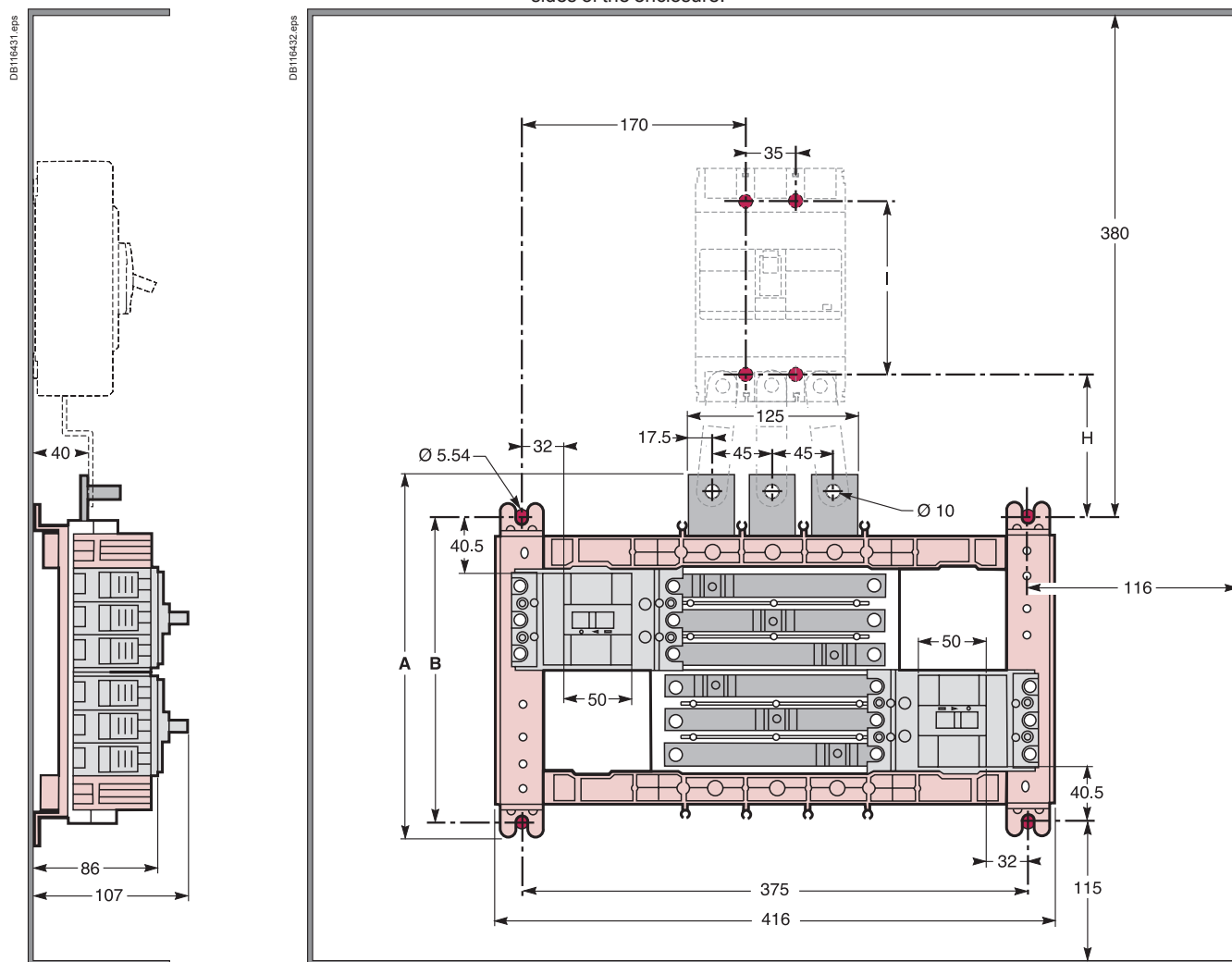

EZB250 - 250 A main busbar rating.

Trim cut-out

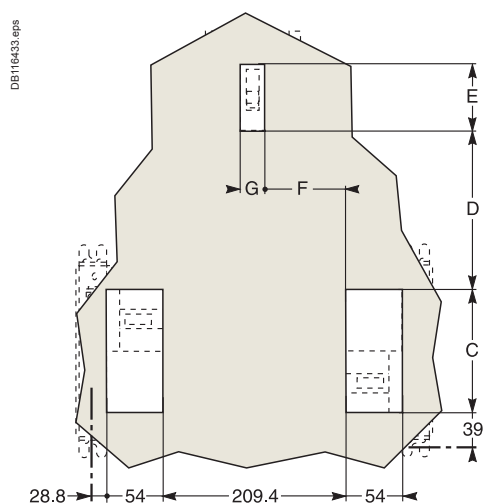

| | A | B | C | D | E | F | G | H | I |
|---------------|-------|-----|-----|-------|----|------|----|-------|-----|
| EZ250 incomer | - | - | - | 187.4 | 52 | 92.7 | 24 | 109.5 | 126 |
| NS incomer | - | - | - | 182.4 | 76 | 90.2 | 29 | 108 | 125 |
| 4 ways | 268.5 | 225 | 147 | - | - | - | - | - | - |
| 6 ways | 343.5 | 300 | 222 | - | - | - | - | - | - |
| 8 ways | 418.5 | 375 | 297 | - | - | - | - | - | - |
| 10 ways | 493.5 | 450 | 372 | - | - | - | - | - | - |
| 12 ways | 568.5 | 525 | 447 | - | - | - | - | - | - |

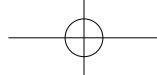

Busbars

Dimensions Busbars EZB400/630

Layout installation EZB400/630

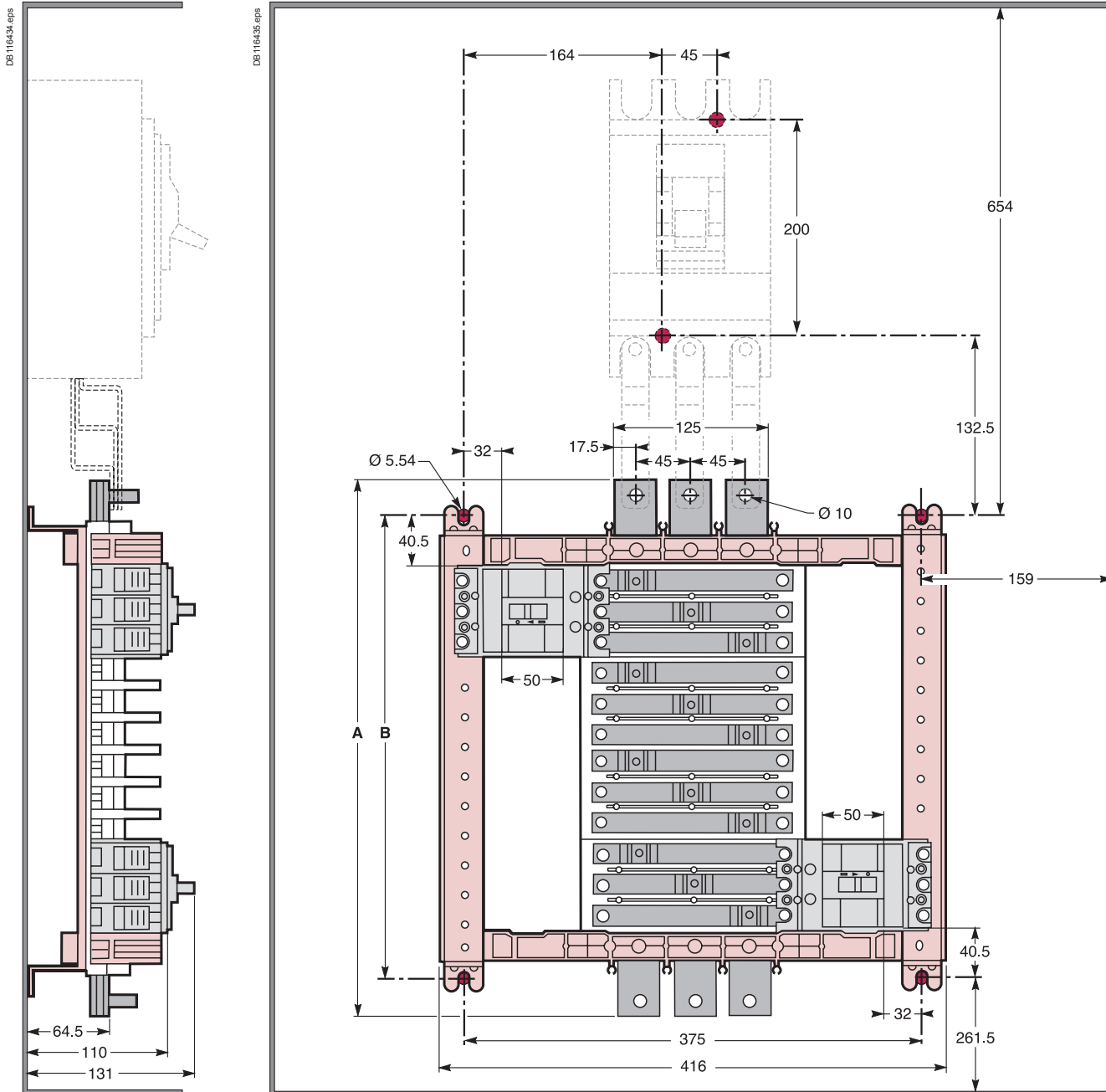

EZB400 and EZB630 - 400 A and 630 A main busbar ratings.

Trim cut-out

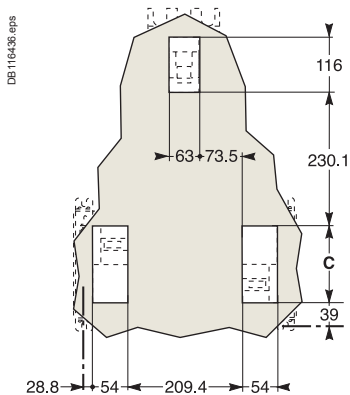

| | A | B | C |
|---------|-----|-----|-----|
| 4 ways | 290 | 225 | 147 |
| 6 ways | 365 | 300 | 222 |
| 8 ways | 440 | 375 | 297 |
| 10 ways | 515 | 450 | 372 |
| 12 ways | 590 | 525 | 447 |

Note: to avoid excess temperature rise on incoming MCCB terminals, panels using 630 A main breaker with these minimum enclosure dimensions require a 7000 mm² ventilation opening (after subtracting effects of screening) at each of the 4 corners of the enclosure.



Dimensions

EasyPact EZC or Compact NSX branch extensions layout

Layout installation for EasyPact EZC or Compact NSX branch extensions

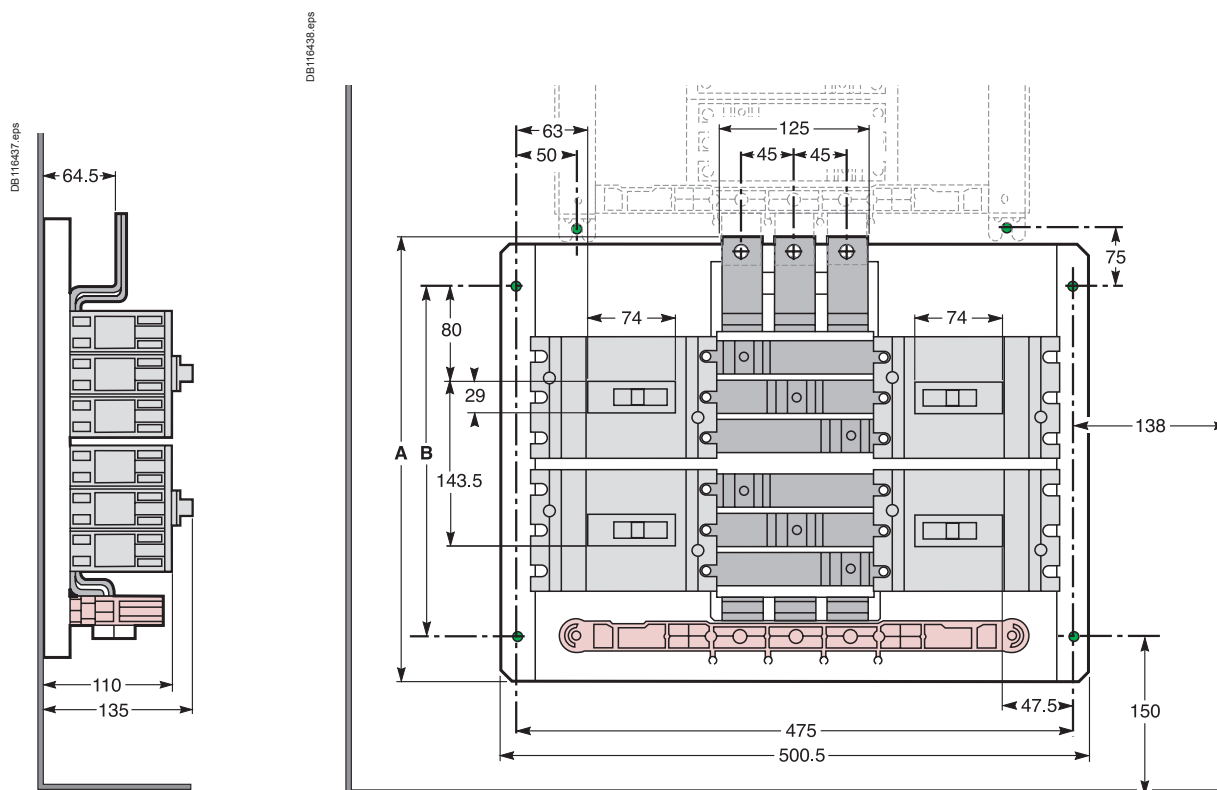

EZBNS2 and EZBNS4 Compact NSX branch breaker extension.

| | A | B | C | D | E | F | G | H |
|--------|-----|-----|------|------|----|------|----|-----|
| EZBNS2 | 270 | 175 | NA | - | - | - | - | - |
| EZBNS4 | 384 | 275 | 85.5 | - | - | - | - | - |
| EZC250 | - | - | 90.5 | 57.5 | 24 | 61 | 52 | 249 |
| NSX250 | - | - | 85.5 | 78.5 | 29 | 45.5 | 76 | 232 |

Trim cut-out

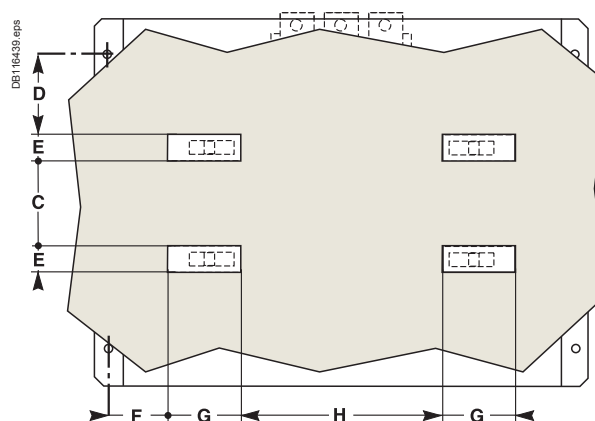

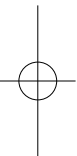

| | |
|--|-------------|
| <i>Presentation</i> | <i>II</i> |
| <i>Functions and characteristics</i> | <i>A-1</i> |
| <i>Busbars</i> | <i>B-1</i> |
| Dimensions | |
| EasyPact Ezc 100 | C-2 |
| EasyPact Ezc 100 A with plug-in | C-4 |
| EasyPact Ezc 250 - Ezc 250/EzcV 250 | C-6 |
| EasyPact Ezc 250 A with plug-in | C-8 |
| EasyPact Ezc 400/630 | C-10 |
| EasyPact Ezc 100 accessories | C-12 |
| EasyPact Ezc 250 accessories | C-13 |
| EasyPact Ezc 400/630 accessories | C-14 |
| Safety clearances and minimum distances | C-15 |
| Temperature derating | C-17 |
| Tripping curves | C-18 |
| Current-limiting curves | C-20 |
| Cascading | C-21 |
| Cascading tables | C-22 |
| Motor protection | C-24 |
| Capacitor protection | C-26 |
| <i>Catalogue numbers</i> | <i>D-1</i> |

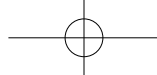

Installation guide

Dimensions EasyPact EZC 100

Dimensions

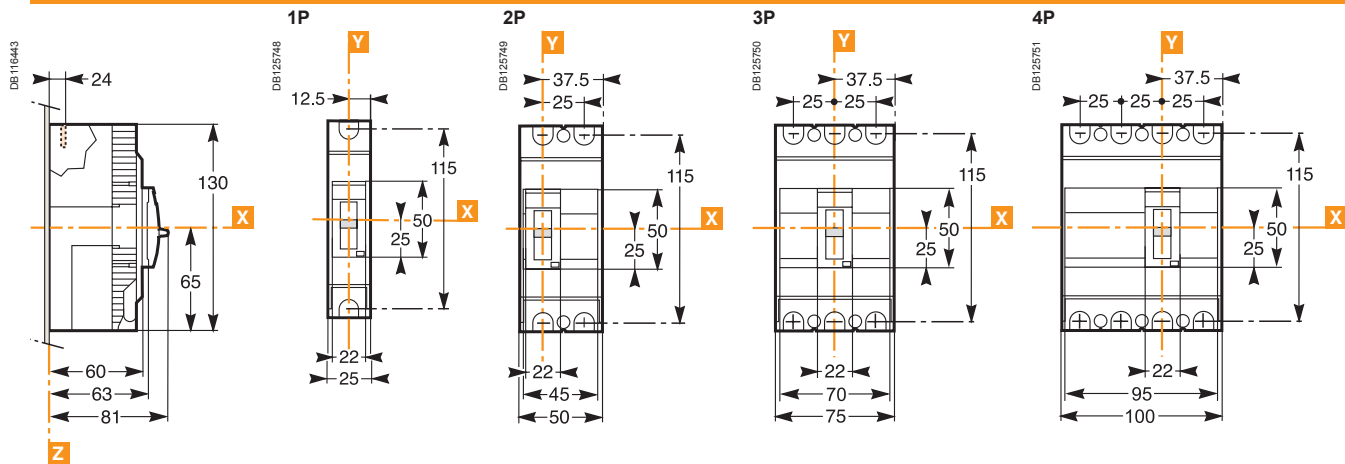

Mounting on plate

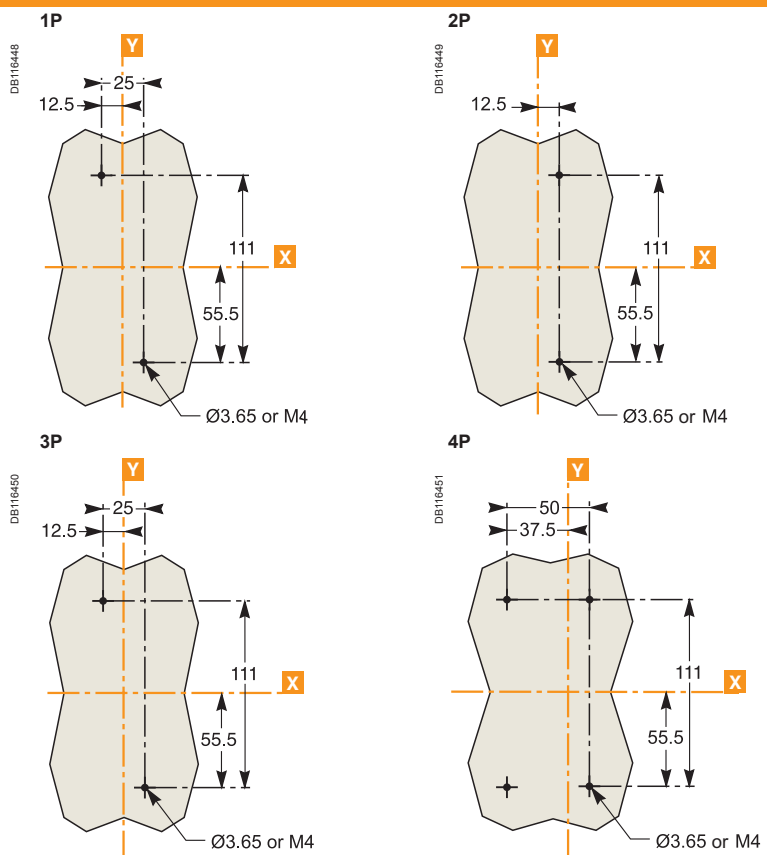

Mounting on DIN rail

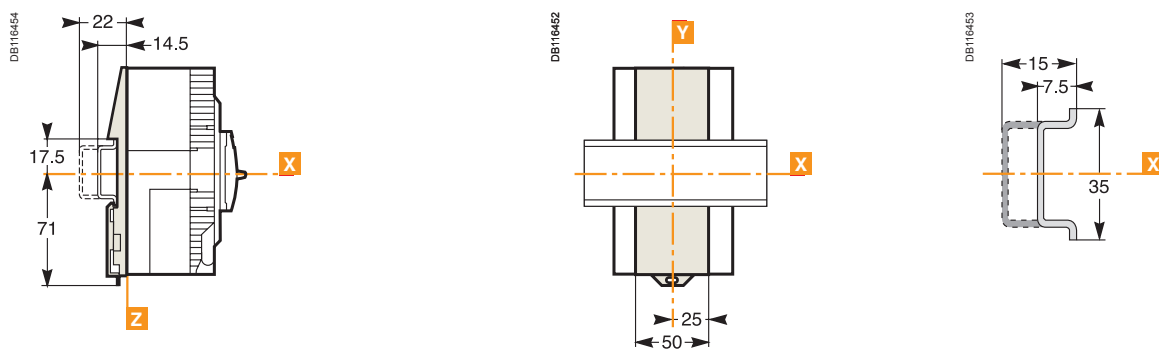

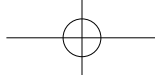

Door cut-out (small)

DB11645

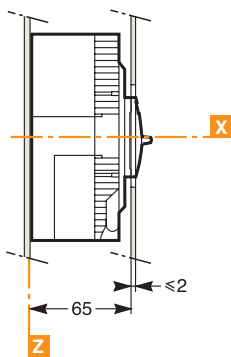

1P, 3P

DB11647

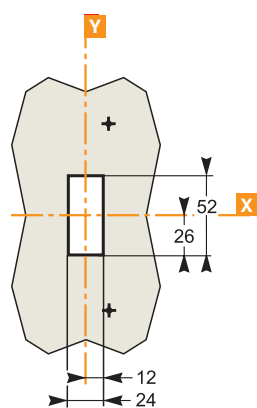

2P

DB11647

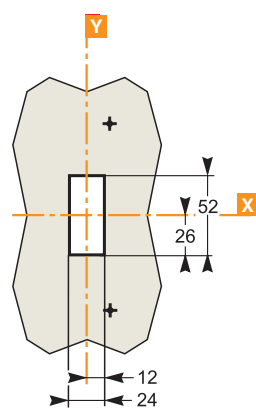

4P

DB11648

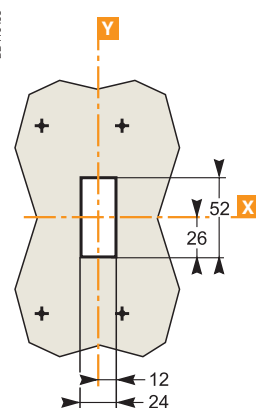

Door cut-out (large)

DB11649

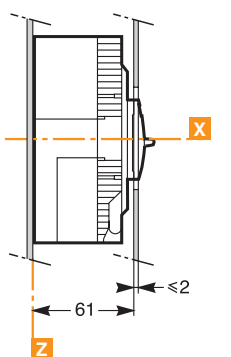

1P

DB11640

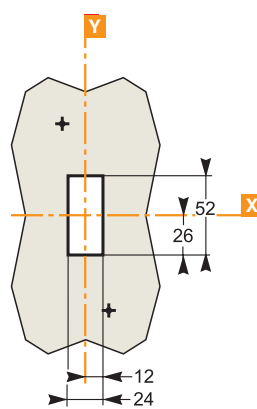

2P

DB11641

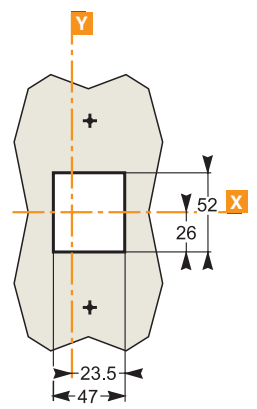

3P

DB11642

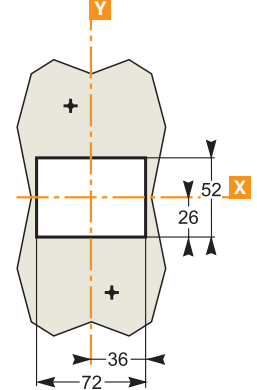

4P

DB11643

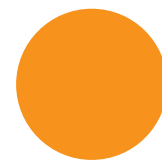
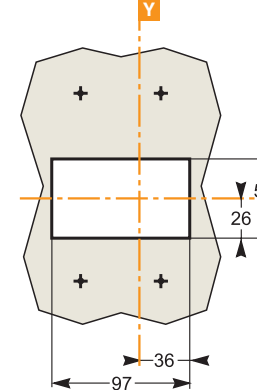

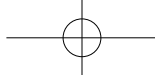

Installation guide

Dimensions EasyPact EZC 100 A with plug-in

Dimensions

DB127536

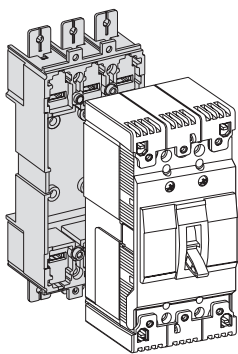

DB127538

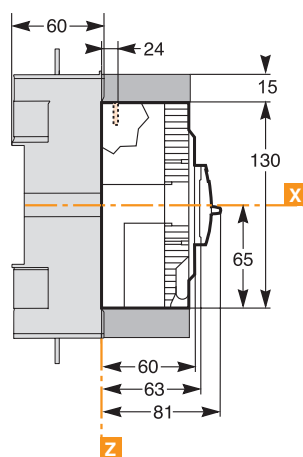

DB127539

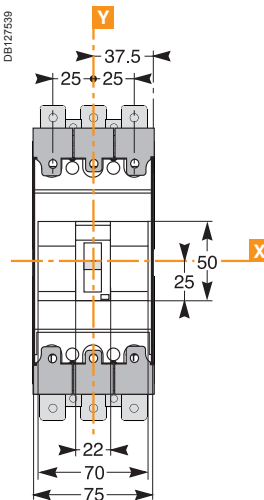

Mounting

Through front panel

DB127541

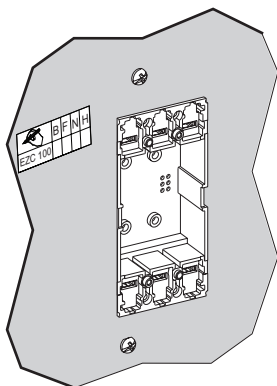

DB127537

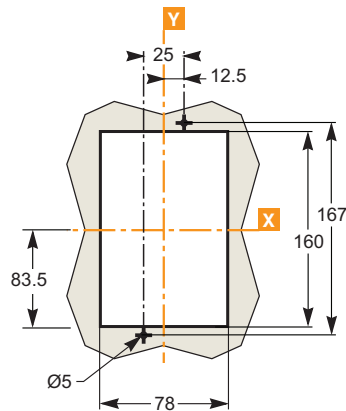

On rail

DB127542

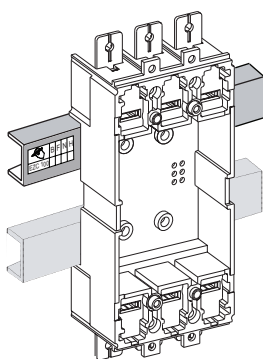

DB127540

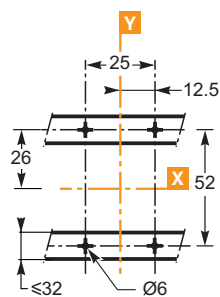

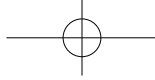

On backplate

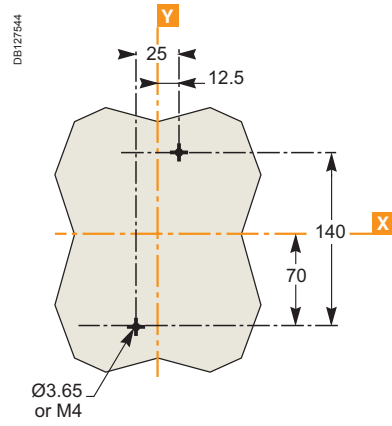
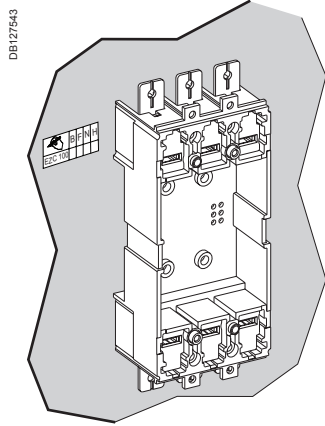

Dimensions - combination

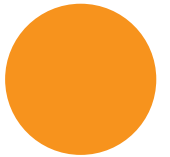
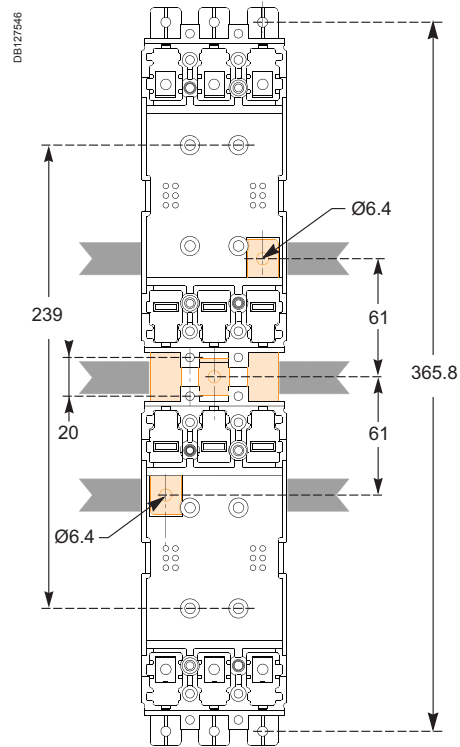
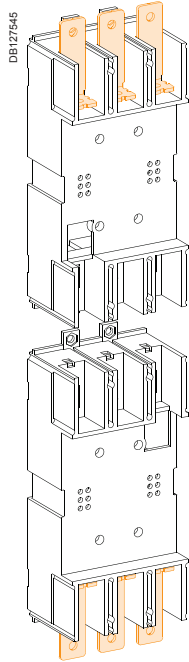

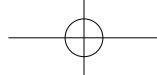

Installation guide

Dimensions EasyPact EZC 250 EZC 250/EZCV 250

Dimensions (EZC250)

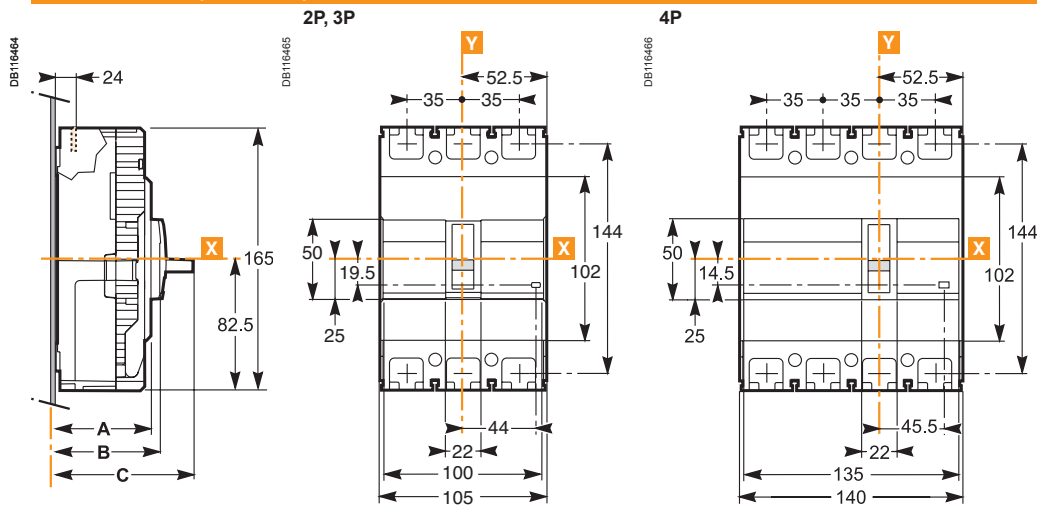

Dimensions (EZCV250)

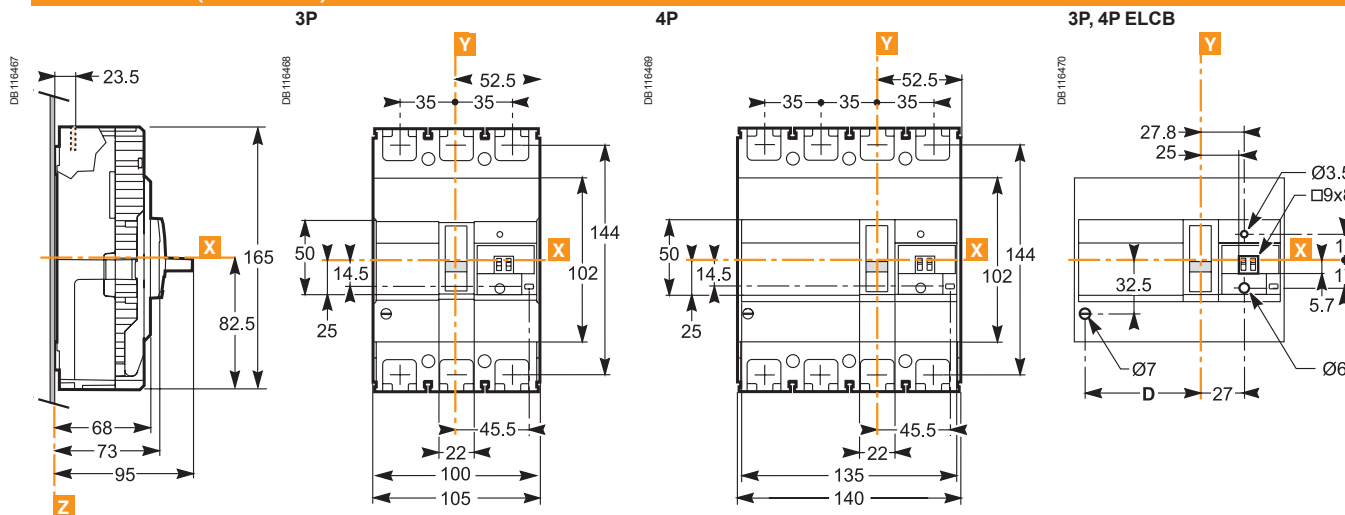

Mounting on plate

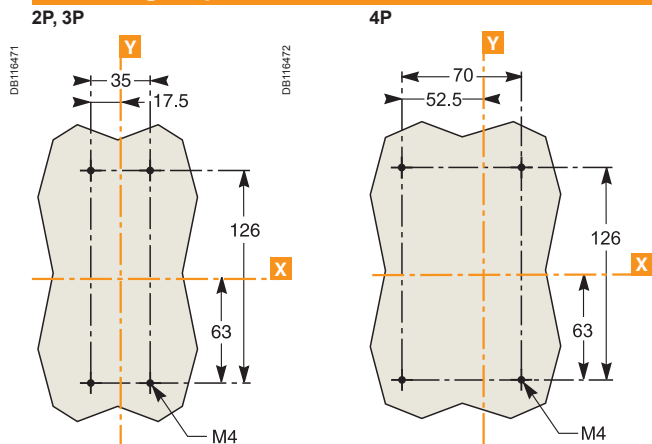

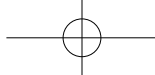

Door cut-out (small)

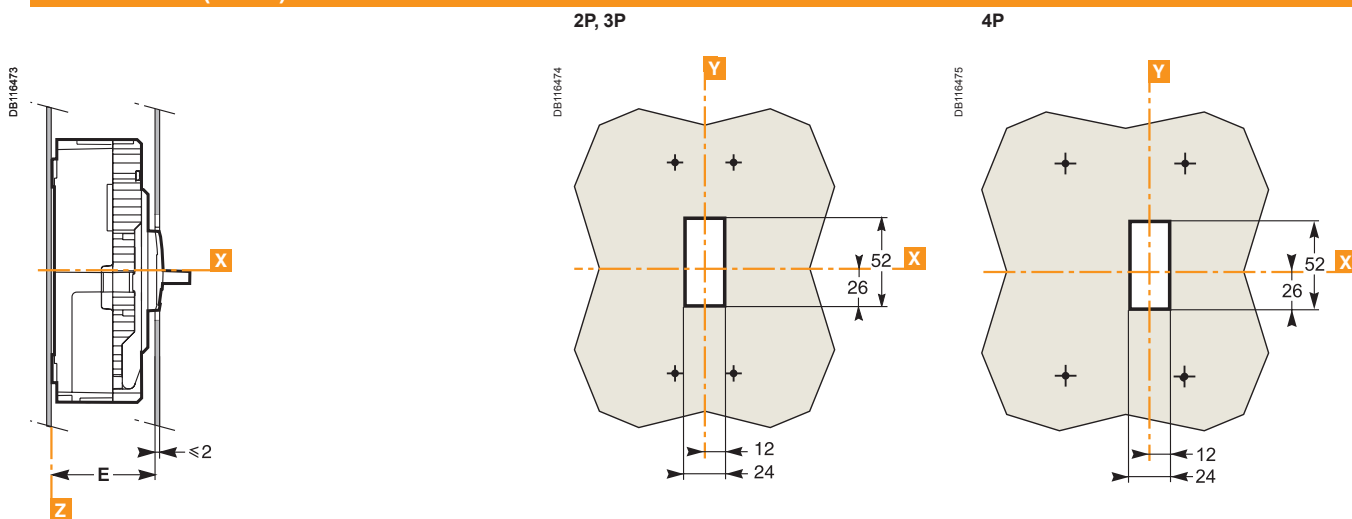

Door cut-out (large)

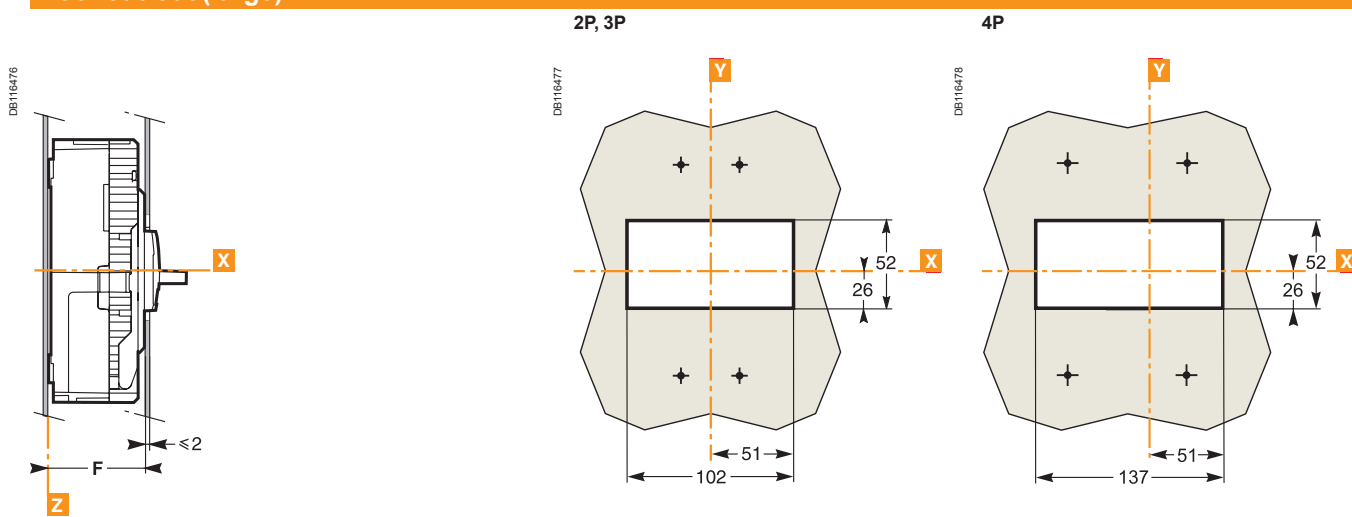

Dimensions (mm)

| | A | B | C | D | E | F |
|----------|----|----|------|------|----|----|
| EZC 2/3P | 60 | 65 | 85.5 | - | 67 | 61 |
| EZC 4P | 68 | 73 | 95 | - | 75 | 69 |
| EZCV 3P | | | | 45.5 | | |
| EZCV 4P | | | | 80.5 | | |



Dimensions

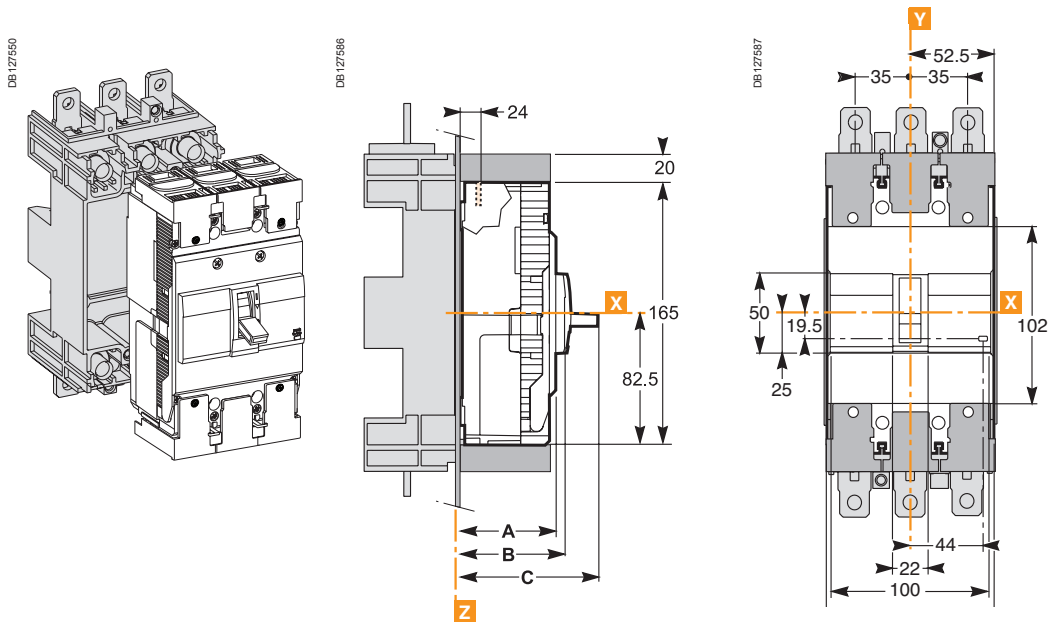

Mounting

Through front panel

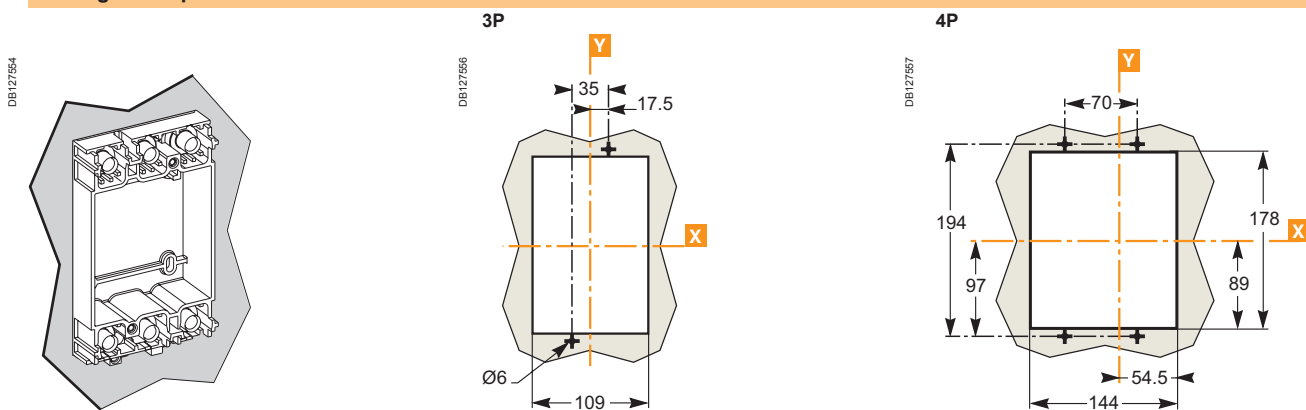

On rail

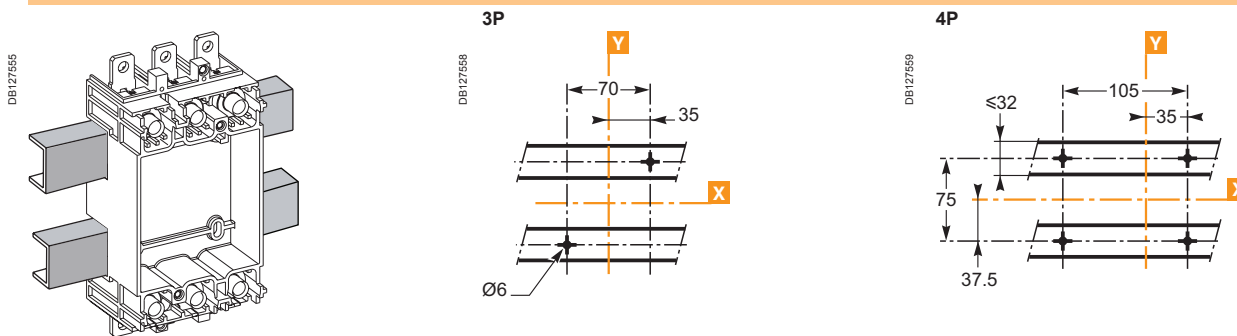

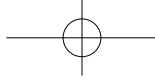

On backplate

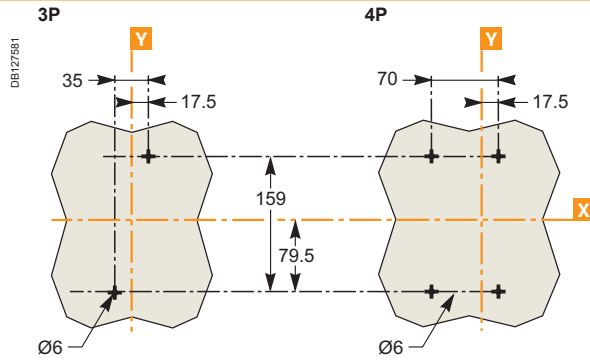
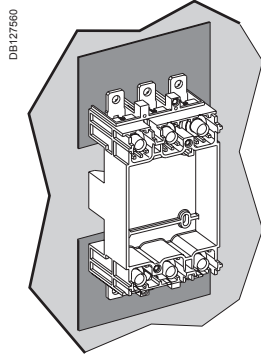

Dimensions

EasyPact EZC 400/630

Dimensions

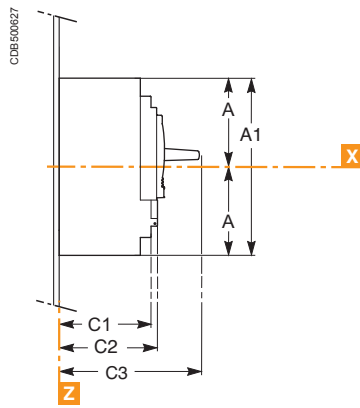

3P

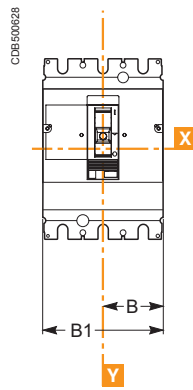

4P

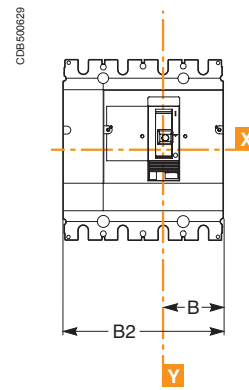

Mounting on plate

On backplate

3P

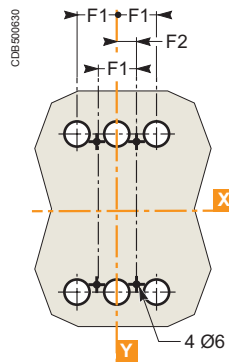

4P

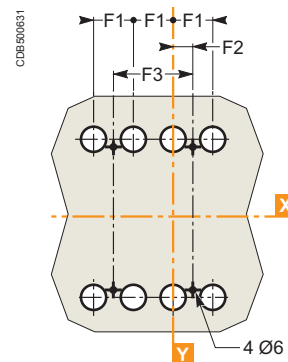

(1) The ØT holes are required for rear connection only.

| A | A1 | B | B1 | B2 | F1 | F2 | F3 |
|-------|-----|----|-----|-----|----|------|----|
| 127.5 | 255 | 70 | 140 | 185 | 45 | 22.5 | 90 |

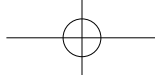

Bare sheet metal

For toggle

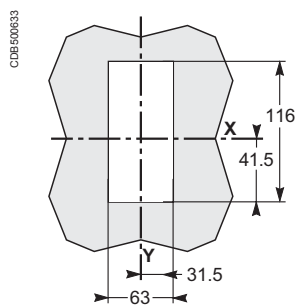
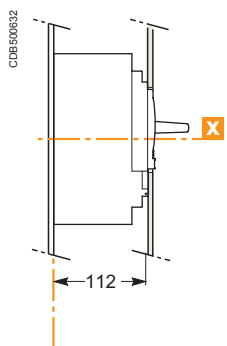

Z

For toggle with access to trip unit

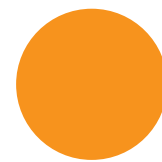
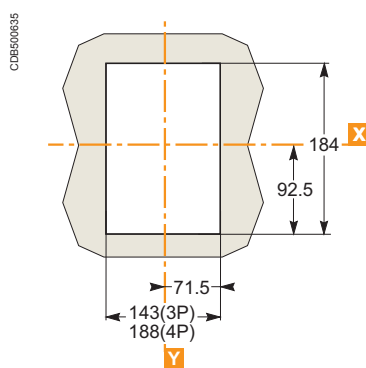
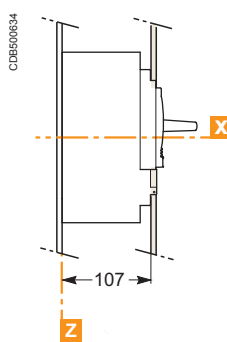

Terminal shields

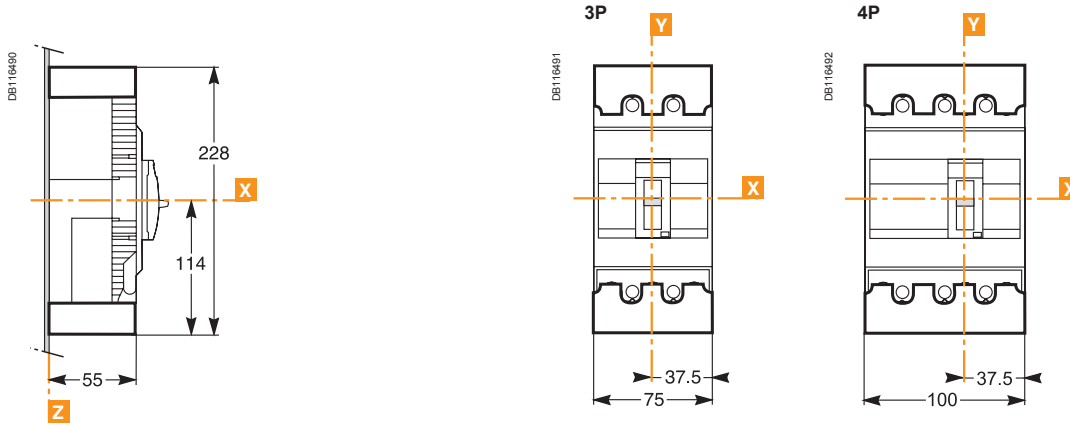

Phase barriers

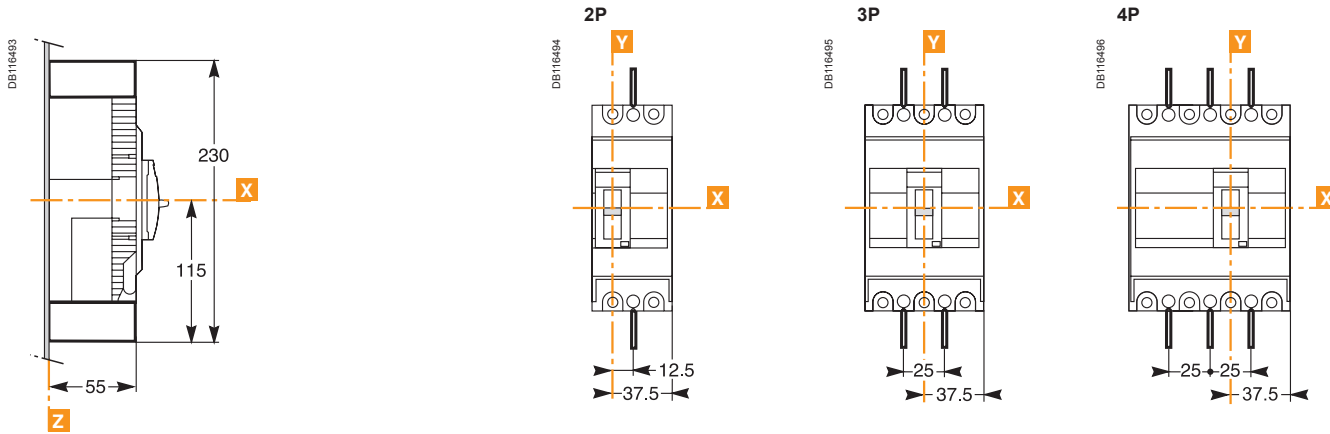

Direct rotary handle

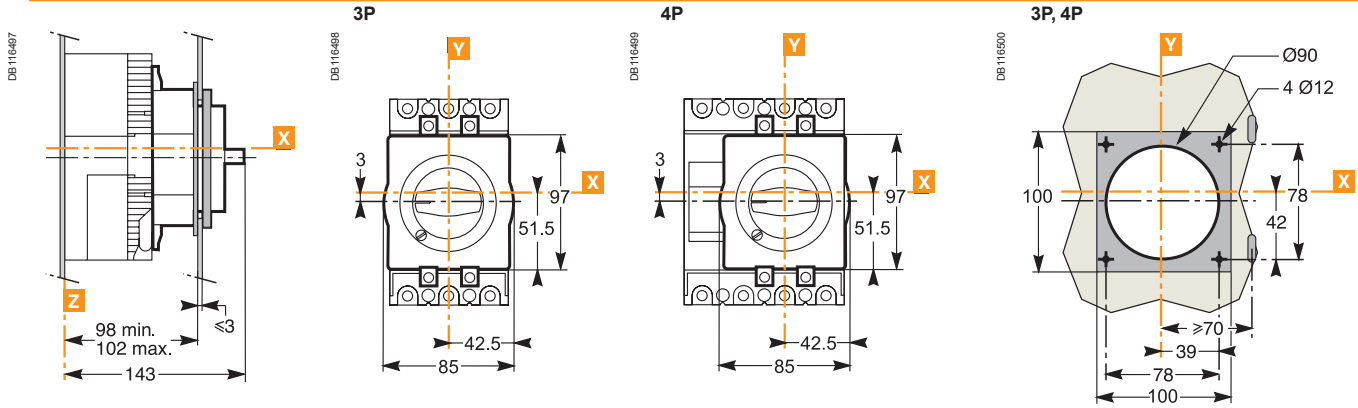

Extended rotary handle

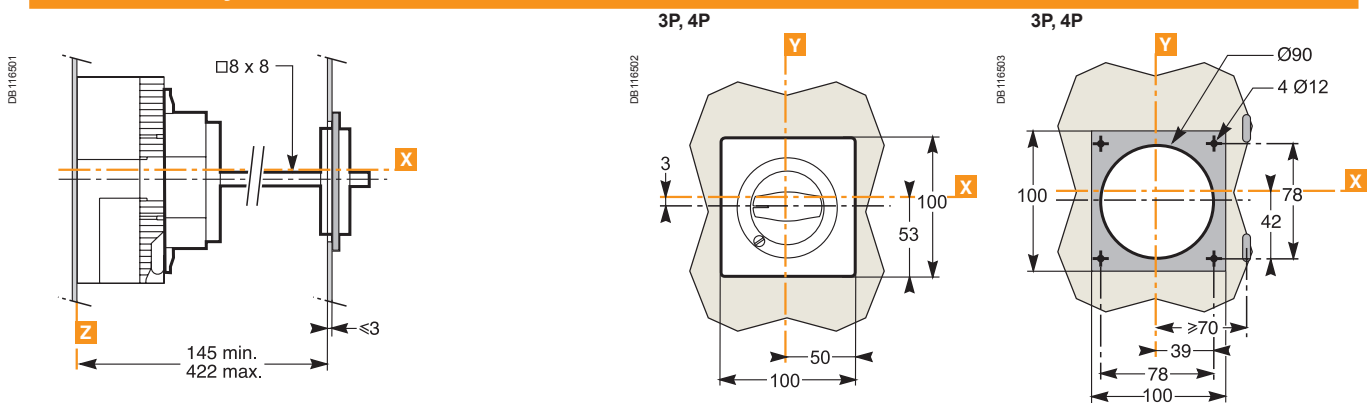

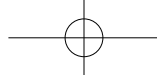

Dimensions

EasyPact EZC 250 accessories

Terminal shields

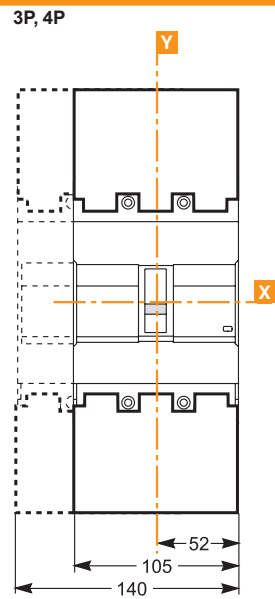
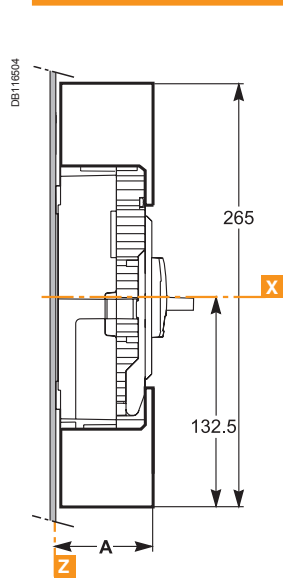

Phase barriers

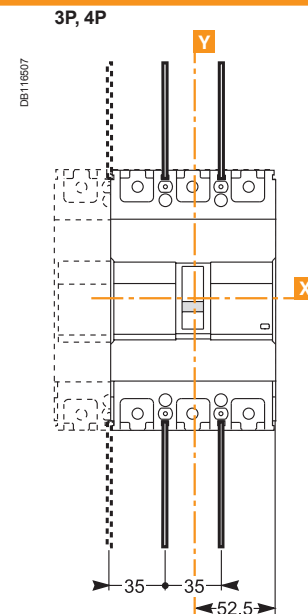
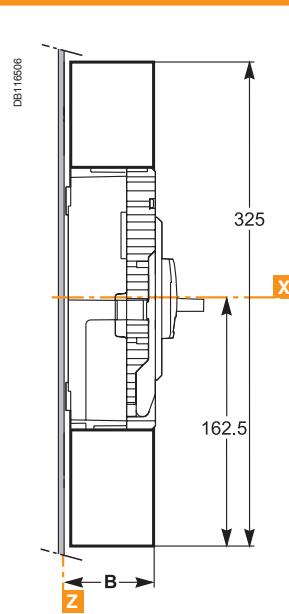

Direct rotary handle

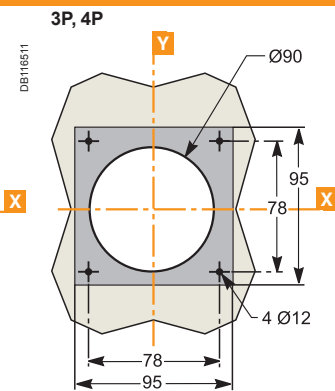
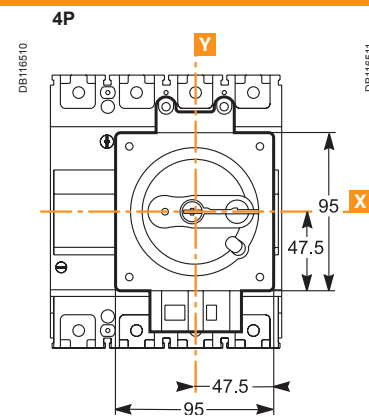
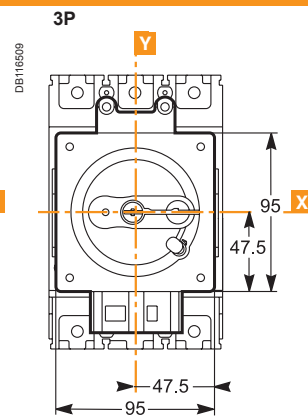
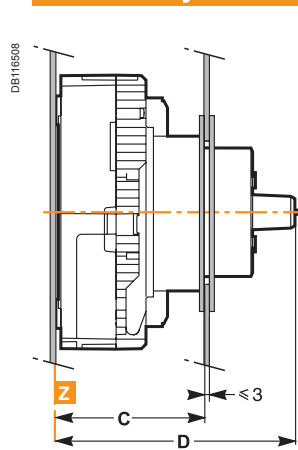

Extended rotary handle

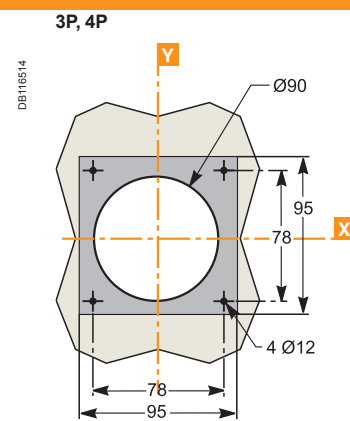
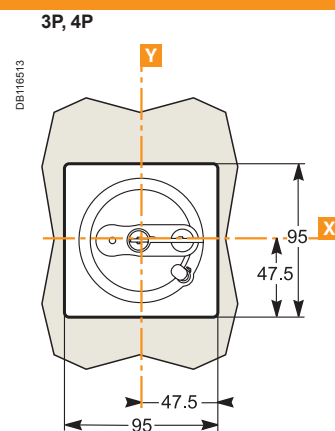
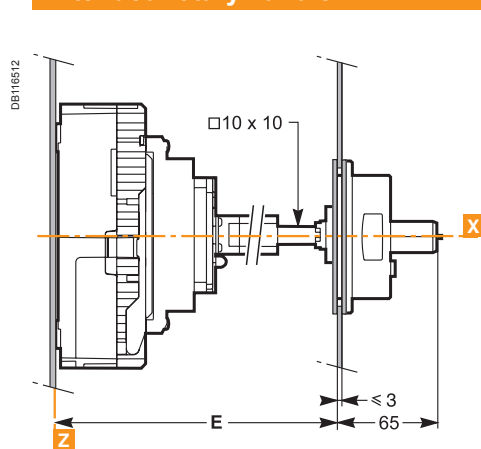

Dimensions (mm)

| | A | B | C | D | E |
|------------|------|----|------------|-----|------------|
| EZC 2/3P | 58.5 | 55 | 93 to 97 | 145 | 137 to 414 |
| EZC 4P | 66.5 | 63 | 101 to 105 | 153 | 145 to 422 |
| EZCV 3P/4P | | | | | |

Terminal shields and Interphase barriers

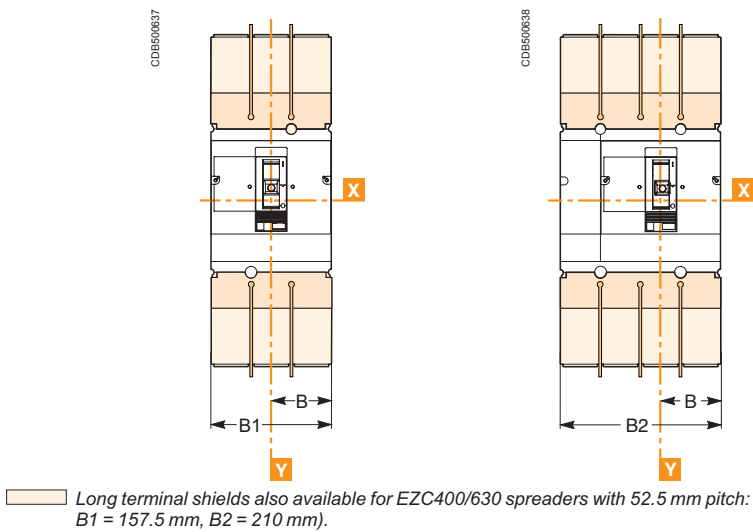
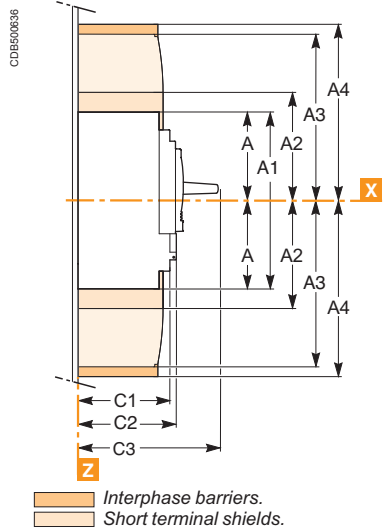

Direct rotary handle

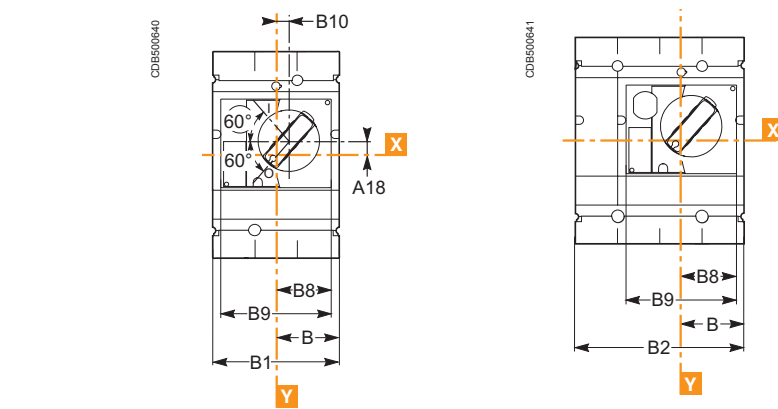
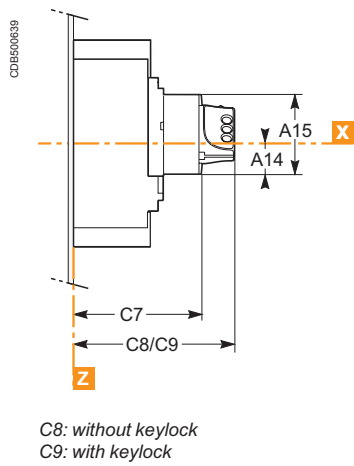

Extended rotary handle

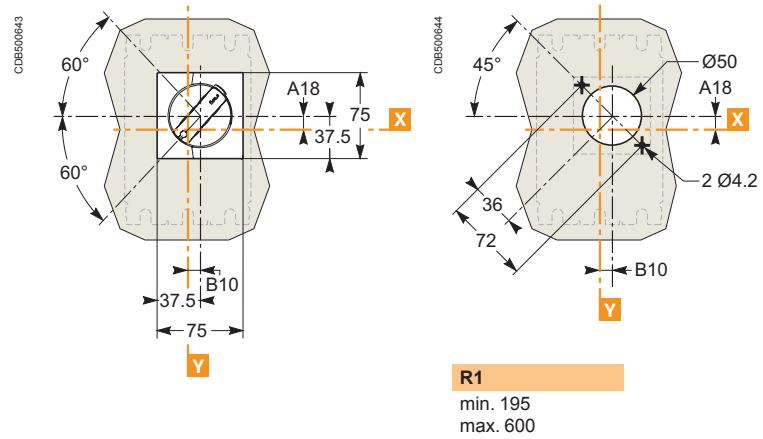
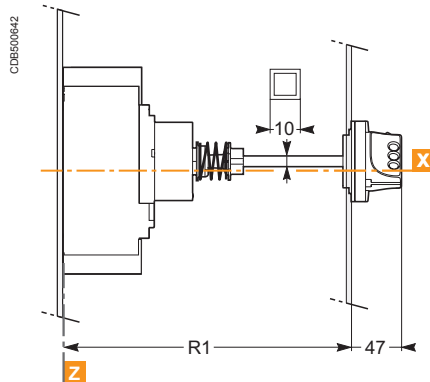

| A | A1 | A2 | A3 | A4 | B | B1 | B2 | C1 | C2 | C3 | F1 | F2 | F3 |
|-------|-----|-------|-----|-----|----|-----|-----|------|-----|-----|----|------|----|
| 127.5 | 255 | 142.5 | 200 | 237 | 70 | 140 | 185 | 95.5 | 110 | 168 | 45 | 22.5 | 90 |

| A14 | A15 | A18 | B8 | B9 | B10 | C7 | C8 | C9 | A18 | B10 |
|-----|-----|------|------|-----|-----|-----|-----|-----|------|-----|
| 40 | 123 | 24.6 | 61.5 | 123 | 5 | 145 | 179 | 188 | 24.6 | 5 |

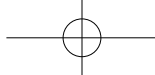

Safety clearances and minimum distances

When installing a circuit breaker, minimum distances (safety clearances) must be maintained between the device and panels, bars and other protection devices installed nearby. These distances, which depend on the ultimate breaking capacity, are defined by tests carried out in accordance with standard IEC 60947-2.

If installation conformity is not checked by type tests, it is also necessary to:

- use insulated bars for circuit-breaker connections
- block off the busbars using insulating screens.

For EasyPact EZC breaker, terminal shields, inter-phase barriers or an insulation isolator are recommended and may be mandatory depending on the utilisation voltage and the type of installation.

Minimal distance between two adjacent circuit breakers

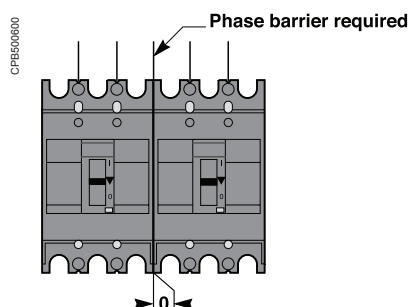

Minimal distance between the circuit breaker and top, bottom or side panels

Minimal distance between the circuit breaker and front or rear panels

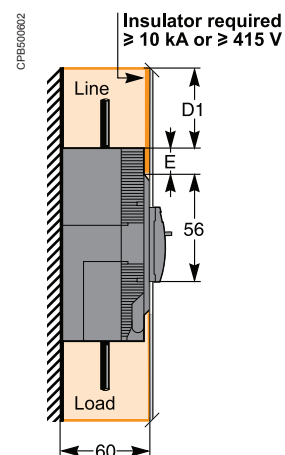
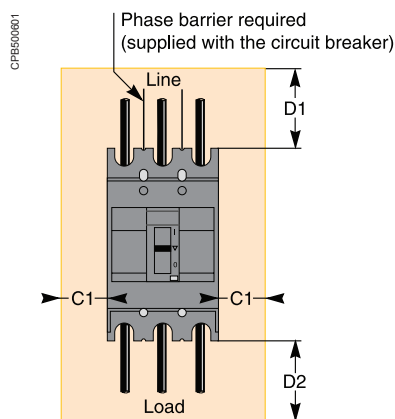

| Dimensions (mm) | Bare or painted sheet metal: | | | | | |
|-------------------------------------|------------------------------|----------------|-----|---------------------------|-----|------|
| | C1 | insulated bars | | bare busbar under voltage | | |
| | | D1 | D2 | D1 | D2 | E |
| EasyPact EZC circuit breaker | | | | | | |
| EZC100B/F/N | 40 | 45 | 45 | 75 | 45 | 40 |
| EZC100H | 40 | 60 | 45 | 75 | 45 | 40 |
| EZC250F/N-EZCV250N | 50 | 60 | 45 | 140 | 45 | 42.5 |
| EZC250H-EZCV250H | 50 | 80 | 45 | 140 | 45 | 42.5 |
| EZC400N | 50 | 120 | 100 | 250 | 100 | 40 |
| EZC400H | 80 | 140 | 100 | 250 | 100 | 40 |
| EZC630N | 50 | 120 | 100 | 250 | 100 | 40 |
| EZC630H | 80 | 140 | 100 | 250 | 100 | 40 |

The mandatory distances when installing EasyPact EZC circuit breakers are calculated from the device case, not taking into account the terminal shields or the phase barriers.

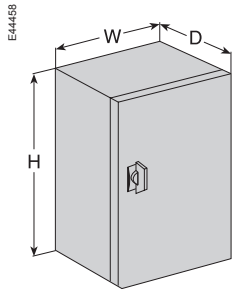

Installation in an enclosure.

Installation in an enclosure

EasyPact EZC circuit breakers can be installed in a metal enclosure together with other devices (contactors, motor-protection circuit breakers, LEDs, etc.).

Minimum enclosure dimensions (3P)

| Circuit breakers | Height (mm) | Depth (mm) ⁽¹⁾ | Width (mm) |
|--------------------|-------------|---------------------------|------------|
| EZC100B/F/N | 200 | 90 | 155 |
| EZC100H | 215 | 90 | 155 |
| EZC250F/N-EZCV250N | 270 | 90 | 205 |
| EZC250H-EZCV250H | 290 | 90 | 205 |
| EZC400N | 480 | 160 | 240 |
| EZC400H | 500 | 160 | 300 |
| EZC630N | 480 | 160 | 240 |
| EZC630H | 500 | 160 | 300 |

⁽¹⁾ With front door.

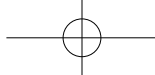

Temperature derating

Ambient temperature

EasyPact EZC devices are equipped with fixed thermal-magnetic trip units.

- EasyPact EZC has been particularly designed to hold 100 % In at 50 °C without tripping in normal condition (except for earth-leakage circuit breakers).
- EasyPact EZC circuit breakers may be used between -25 °C and +70 °C.
- EasyPact EZC circuit breakers should be put into service under normal ambient operating temperature conditions. Exceptionally, the circuit breaker may be put into service when the ambient temperature is between -35 °C and -25 °C.
- the permissible storage-temperature range for EasyPact EZC circuit breakers in the original packing is -35 °C to +85 °C.

To determine tripping times using time/current curves, use Ir values corresponding to the thermal setting on the device, corrected as indicated in the tables below.

| Rated current (A) | 25 °C | 40 °C | 45 °C | 50 °C | 55 °C | 60 °C | 65 °C | 70 °C |
|-------------------|-------|-------|-------|-------|-------|-------|-------|-------|
| EZC100 | | | | | | | | |
| 15 | 17.0 | 15.7 | 15.3 | 15.0 | 14.7 | 14.6 | 14.2 | 13.8 |
| 16 | 18.1 | 16.7 | 16.3 | 16.0 | 15.7 | 15.6 | 15.1 | 14.7 |
| 20 | 21.8 | 20.4 | 20.2 | 20.0 | 19.7 | 19.2 | 18.9 | 18.5 |
| 25 | 26.9 | 25.7 | 25.3 | 25.0 | 24.7 | 24.5 | 24.3 | 24.0 |
| 30 | 34.5 | 31.4 | 30.7 | 30.0 | 29.4 | 29.1 | 28.5 | 28.0 |
| 32 | 36.8 | 33.5 | 32.7 | 32.0 | 31.4 | 31.0 | 30.4 | 29.9 |
| 40 | 42.8 | 40.9 | 40.4 | 40.0 | 39.5 | 38.0 | 37.6 | 37.1 |
| 45 | 48.8 | 46.9 | 45.9 | 45.0 | 44.4 | 43.3 | 42.6 | 41.9 |
| 50 | 54.2 | 52.1 | 51.0 | 50.0 | 49.3 | 48.1 | 47.3 | 46.6 |
| 60 | 64.4 | 61.8 | 60.9 | 60.0 | 59.0 | 57.5 | 56.6 | 55.7 |
| 63 | 67.6 | 64.9 | 63.9 | 63.0 | 62.0 | 60.4 | 59.4 | 58.5 |
| 75 | 78.6 | 76.8 | 75.9 | 75.0 | 73.5 | 70.4 | 69.8 | 69.1 |
| 80 | 84.4 | 82.2 | 81.1 | 80.0 | 78.6 | 77.3 | 76.7 | 76.1 |
| 100 | 109 | 103 | 101 | 100 | 99 | 94 | 94 | 93 |
| EZC250 | | | | | | | | |
| 63 | 77 | 69 | 66 | 63 | 60 | 56 | 53 | 49 |
| 80 | 93 | 86 | 83 | 80 | 77 | 74 | 71 | 68 |
| 100 | 115 | 106 | 103 | 100 | 96 | 93 | 89 | 85 |
| 125 | 148 | 135 | 130 | 125 | 120 | 114 | 109 | 103 |
| 150 | 174 | 160 | 155 | 150 | 145 | 139 | 134 | 128 |
| 160 | 186 | 171 | 166 | 160 | 154 | 148 | 142 | 136 |
| 175 | 207 | 188 | 182 | 175 | 168 | 161 | 153 | 145 |
| 200 | 236 | 215 | 208 | 200 | 192 | 184 | 175 | 166 |
| 225 | 268 | 244 | 235 | 225 | 215 | 205 | 194 | 182 |
| 250 | 297 | 270 | 260 | 250 | 239 | 228 | 215 | 203 |
| EZCV250 | | | | | | | | |
| 63 | 72 | 63 | 60 | 56 | 53 | 49 | 44 | 39 |
| 80 | 89 | 80 | 77 | 73 | 70 | 66 | 62 | 58 |
| 100 | 113 | 100 | 95 | 91 | 86 | 80 | 74 | 68 |
| 125 | 140 | 125 | 120 | 114 | 108 | 102 | 95 | 88 |
| 150 | 163 | 150 | 145 | 141 | 136 | 131 | 125 | 120 |
| 160 | 177 | 160 | 154 | 148 | 141 | 135 | 127 | 120 |
| 175 | 194 | 175 | 168 | 161 | 154 | 146 | 138 | 126 |
| 200 | 223 | 200 | 192 | 183 | 175 | 165 | 155 | 144 |
| 225 | 245 | 225 | 218 | 211 | 203 | 196 | 180 | 162 |
| 250 | 277 | 250 | 240 | 230 | 220 | 209 | 198 | 180 |
| EZC400/630 | | | | | | | | |
| 250 | 269 | 250 | 244 | 238 | 231 | 225 | 219 | 213 |
| 320 | 343 | 320 | 312 | 303.6 | 295 | 286 | 277 | 267.7 |
| 400 | 429 | 400 | 390 | 379.3 | 368.5 | 357.3 | 345.8 | 334 |
| 500 | 530 | 500 | 489.6 | 479 | 468 | 457 | 445.4 | 433.6 |
| 600 | 637 | 600 | 587 | 574 | 560.6 | 547 | 532.7 | 518 |

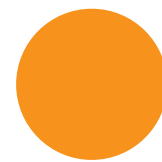

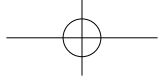

EasyPact EZC100 TM trip units

15-16 A

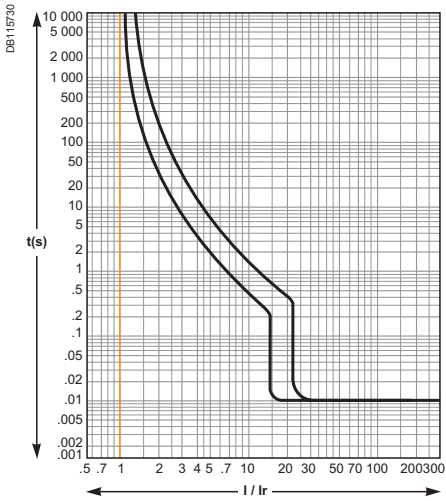

20 A

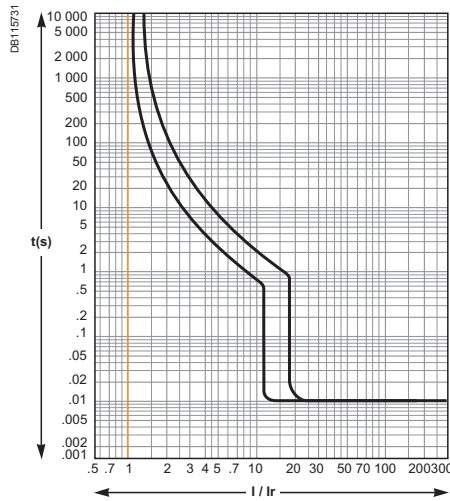

25 A

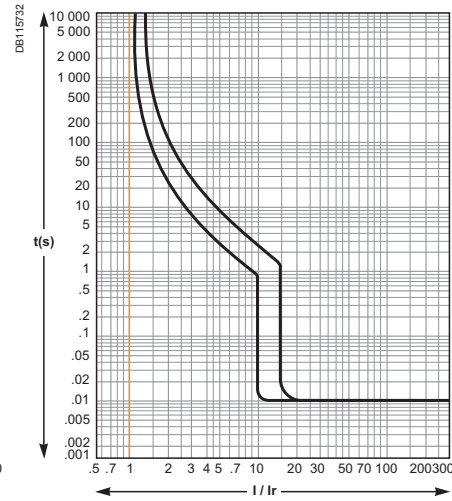

30-32 A

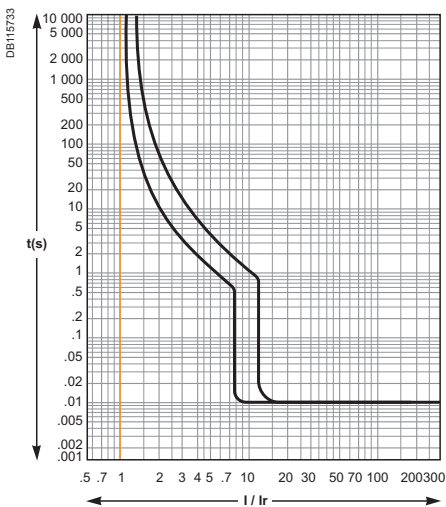

40 A

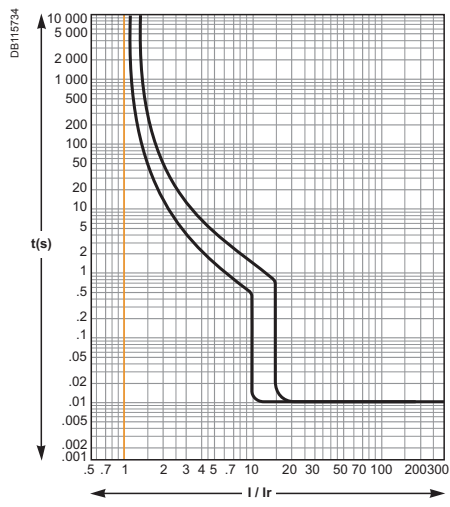

45-50 A

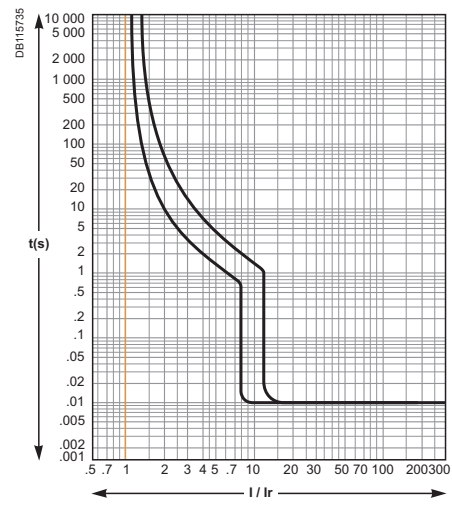

60-63 A

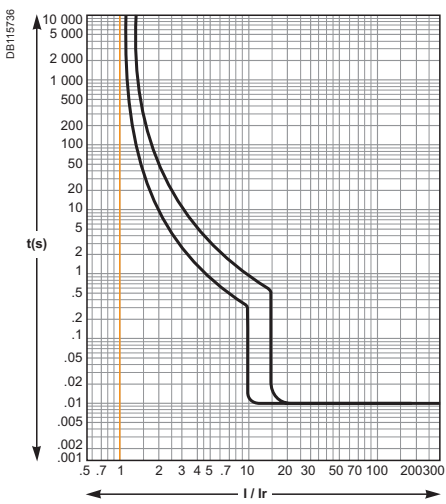

75 A

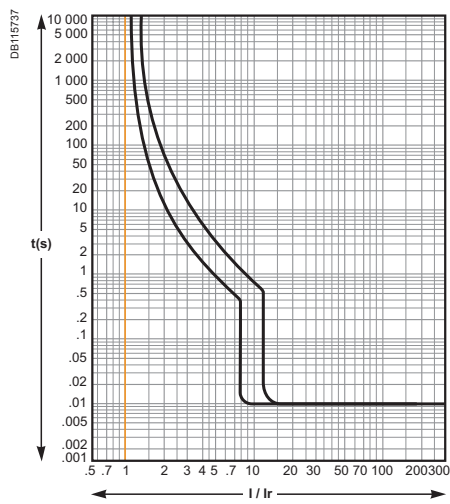

80 A

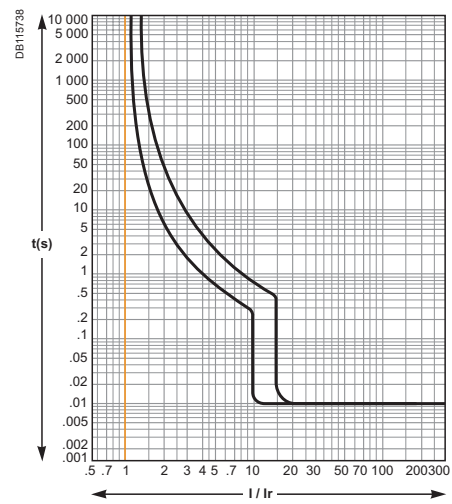

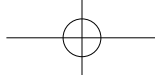

EasyPact EZC100 TM trip units (cont.)

100 A

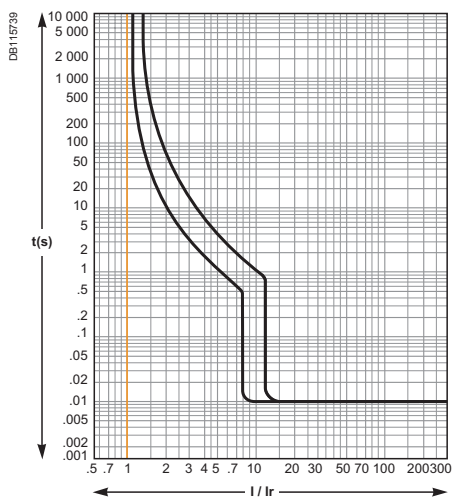

EasyPact EZC250 TM trip units

63-80-100-125 A

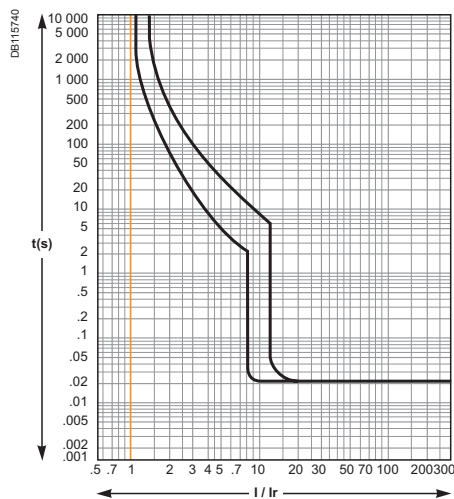

150-160-175-200 A

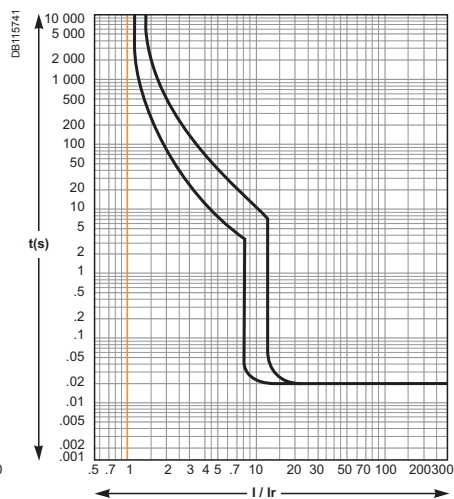

225-250 A

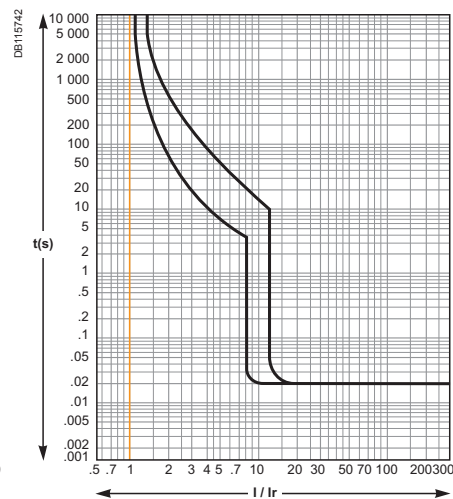

EasyPact EZC400 TM trip units

320-350-400 A

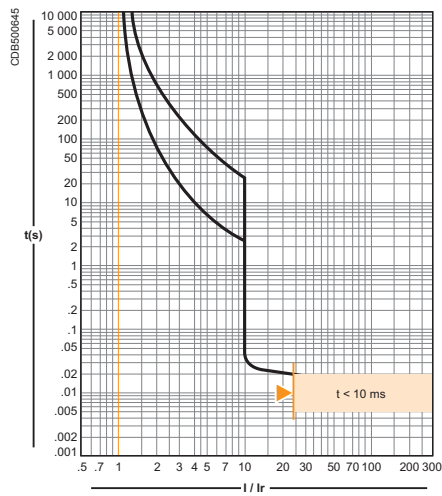

EasyPact EZC630 TM trip units

TM500D

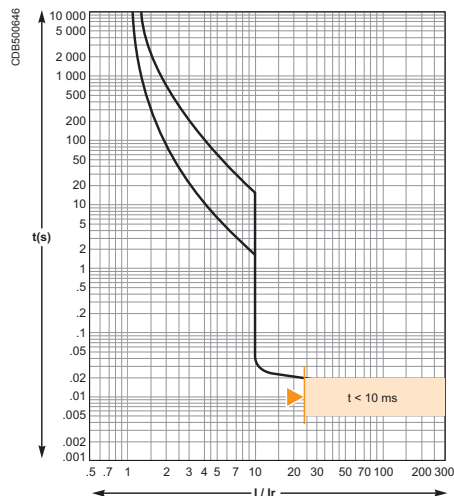

TM600D

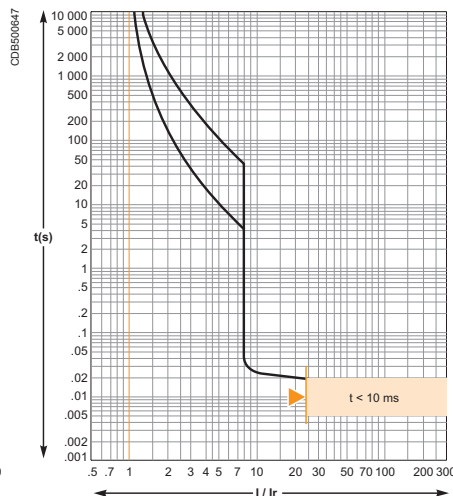

Reflex tripping.

The limiting capacity of a circuit breaker is its aptitude to limit short-circuit currents.

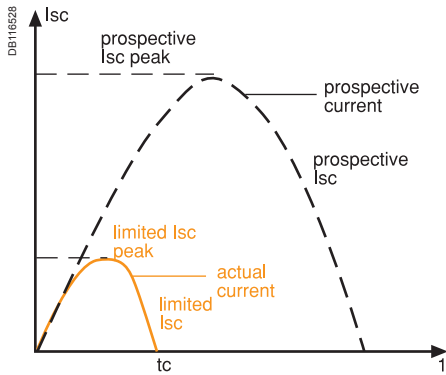

The exceptional limiting capacity of the EasyPact EZC range greatly reduces the forces created by fault currents in devices. The result is a major increase in breaking performance.

The I_{cs} value, defined by IEC standard 60947-2, is guaranteed by tests comprising the following operations:

- break three times consecutively a fault current equal from 25% to 100% of I_{cu}
- check that the device continues to function normally:
 - it conducts the rated current without abnormal temperature rises
 - protection functions perform within the limits specified by the standard
 - suitability for isolation is not impaired.

Longer service life of electrical installations

Current-limiting circuit breakers greatly reduce the negative effects of short-circuits on installations.

Thermal effects

Less temperature rise in conductors, therefore longer service life for cables.

Mechanical effects

Reduced electrodynamic forces, therefore less risk of electrical contacts or busbars being deformed or broken.

Electromagnetic effects

Less disturbances for measuring devices located near electrical circuits.

Economy by means of cascading

Cascading is a technique directly derived from current limiting. Circuit breakers with breaking capacities less than the prospective short-circuit current may be installed downstream of a limiting circuit breaker. The breaking capacity is reinforced by the limiting capacity of the upstream device.

It follows that substantial savings can be made on downstream equipment and enclosures.

Current-limiting curves

The current-limiting capacity of a circuit breaker is expressed by two curves which are a function of the prospective short-circuit current (the current which would flow if no protection devices were installed):

- the actual peak current (limited current),
- thermal stress (A²s), i.e. the energy dissipated by the short-circuit in a conductor with a resistance of 1 Ω.

Current limiting curves 380/415 V AC

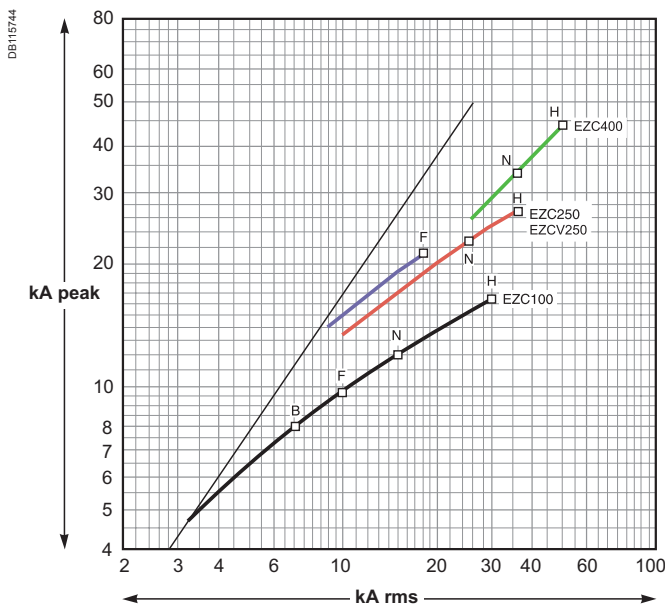

Thermal-stress curves 380/415 V AC

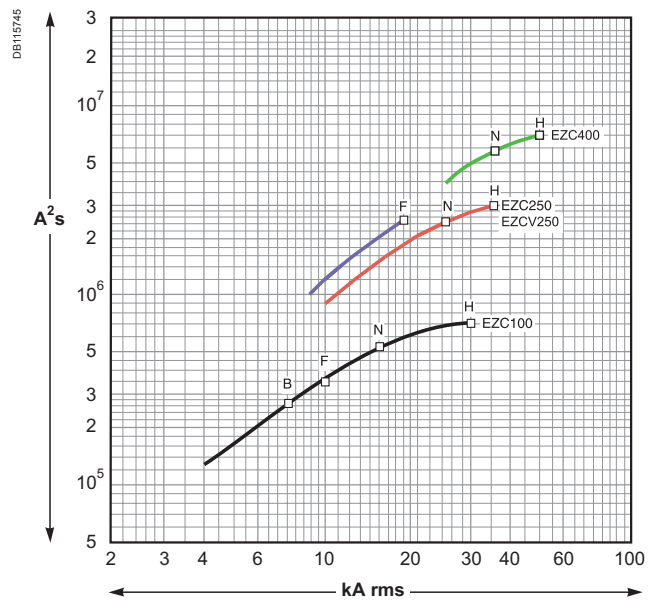



Cascading

What is cascading?

Cascading is the use of the current limiting capacity of circuit breakers at a given point to permit installation of lower-rated and therefore lower-cost circuit breakers downstream.

The upstream compact circuit breakers acts as a barrier against short-circuit currents. In this way, downstream circuit breakers with lower breaking capacities than the prospective short-circuit (at their point of installation) operate under their normal breaking conditions.

Since the current is limited throughout the circuit controlled by the limiting circuit breaker, cascading applies to all switchgear downstream. It is not restricted to two consecutive devices.

General use of cascading

With cascading, the devices can be installed in different switchboards. Thus, in general, cascading refers to any combination of circuit breakers where a circuit breaker with a breaking capacity less than the prospective I_{sc} at its point of installation can be used. Of course, the breaking capacity of the upstream circuit breaker must be greater than or equal to the prospective short-circuit current at its point of installation.

The combination of two circuit breakers in cascading configuration is covered by the IEC 60947-2.

Coordination between circuit breakers

The use of a protective device possessing a breaking capacity less than the prospective short-circuit current at its installation point is permitted as long as another device is installed upstream with at least the necessary breaking capacity. In this case, the characteristics of the two devices must be coordinated in such a way that the energy let through by the upstream device is not more than that which can be withstood by the downstream device and the cables protected by these devices without damage.

Cascading can only be checked by laboratory tests and the possible combinations can be specified only by the circuit breaker manufacturer.

220/240 V network downstream from a 380/415 V network

For 1P + N or 2P circuit breakers connected between the phase and neutral on a 380/415 V network, with a TT or TNS neutral system, consult the 220/240 V cascading table to determine cascading possibilities between upstream and downstream circuit breakers.

Economy by means of cascading

Thanks to cascading, circuit breakers with breaking capacities less than the prospective short-circuit current may be installed downstream from a current limiting circuit breaker.

It follows that substantial savings can be made on downstream switchgear and enclosures.

Cascading tables

Schneider Electric cascading tables are:

- drawn up on the basis of calculations (comparison between the energy limited by the upstream device and the maximum permissible thermal stress for the downstream device)

- verified experimentally in accordance with IEC standard 60947-2.

For distribution systems with 220/240 V, 380/415 V and 440 V between phases, the tables of the following pages indicate cascading possibilities between upstream Compact/EasyPact EZC and downstream Multi 9 and EasyPact EZC circuit breakers.

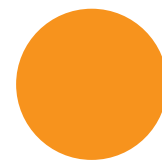
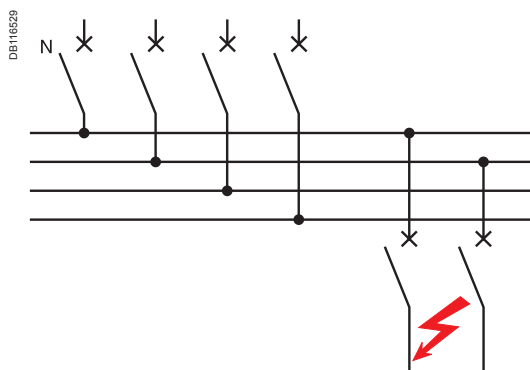

DE127584

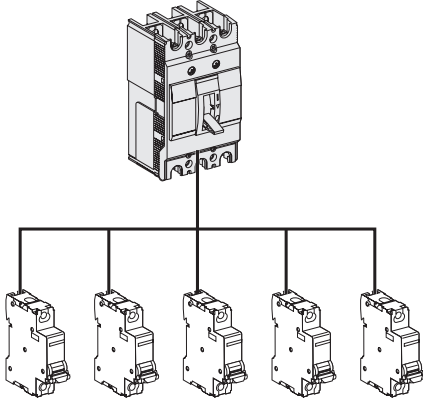

Network 220/240 V

| Upstream | EZC100F | EZC100N | EZC100H |
|-------------------------|----------------------------|---------|---------|
| Breaking capacity kArms | 25 | 25 | 100 |
| Downstream | Enhanced breaking capacity | | |
| iC60a | 10 | 25 | 50 |
| iC60N | 20 | 25 | 65 |
| iC60H | 30 | - | 65 |

| Upstream | EZC250F | EZC250N EZCV250N | EZC250H EZCV250H | NSX250H |
|--------------------------|----------------------------|---------------------|---------------------|---------|
| Breaking capacity kA rms | 25 | 50 | 85 | 100 |
| Downstream | Enhanced breaking capacity | | | |
| EZC100B | 10 | - | 15 | 20 |
| EZC100F | 25 | - | 30 | 50 |
| EZC100N | 25 | - | 36 | 50 |
| EZC100H | 100 | - | - | - |

| Upstream | EZC400N | EZC400H | NB400 NB630 | NSX400N NSX630N | NSX400H NSX630H |
|--------------------------|----------------------------|---------|----------------|--------------------|--------------------|
| Breaking capacity kA rms | 40 | 70 | 85 | 85 | 100 |
| Downstream | Enhanced breaking capacity | | | | |
| EZC100B | 10 | 20 | 20 | 20 | 20 |
| EZC100F | 25 | 40 | 40 | 50 | 50 |
| EZC100N | 25 | 40 | 40 | 50 | 50 |
| EZC100H | 100 | - | - | - | - |
| EZC250F | 25 | 40 | 40 | 50 | 50 |
| EZC/EZCV250N | 50 | - | 70 | 85 | 85 |
| EZC/EZCV250H | 85 | - | 100 | - | 100 |

Network 380/415 V

| Upstream | EZC100F | EZC100N | EZC100H |
|--------------------------|----------------------------|---------|---------|
| Breaking capacity kA rms | 10 | 15 | 30 |
| Downstream | Enhanced breaking capacity | | |
| iC60a | 6 | 10 | 15 |
| iC60N | 10 | - | 15 |
| iC60H | 15 | - | 15 |

| Upstream | EZC250F | EZC250N EZCV250N | EZC250H EZCV250H | NSX250H |
|--------------------------|----------------------------|---------------------|---------------------|---------|
| Breaking capacity kA rms | 18 | 25 | 36 | 70 |
| Downstream | Enhanced breaking capacity | | | |
| EZC100B | 7.5 | - | - | 15 |
| EZC100F | 10 | - | 15 | 30 |
| EZC100N | 15 | - | 25 | 50 |
| EZC100H | 30 | - | 36 | 70 |

| Upstream | EZC400N | EZC400H | NB400 NB630 | NSX400N NSX630N | NSX400H NSX630H |
|--------------------------|----------------------------|---------|----------------|--------------------|--------------------|
| Breaking capacity kA rms | 36 | 50 | 30 | 50 | 70 |
| Downstream | Enhanced breaking capacity | | | | |
| EZC100B | 7.5 | - | - | - | - |
| EZC100F | 10 | - | - | - | - |
| EZC100N | 15 | 20 | 20 | 20 | 30 |
| EZC100H | 30 | 36 | - | 45 | 50 |
| EZC250F | 18 | 20 | 20 | 20 | 20 |
| EZC/EZCV250N | 25 | 36 | 30 | 36 | 40 |
| EZC/EZCV250H | 36 | - | - | 45 | 50 |

DE127895

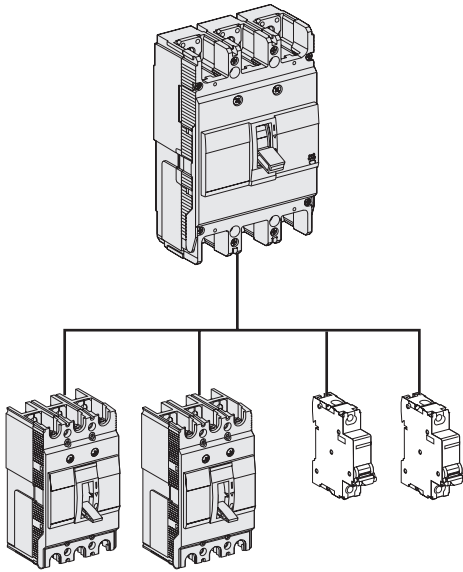

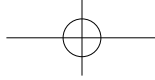

Network 440 V

| Upstream | | EZC250F | EZC250N EZCV250N | EZC250H EZCV250H |
|--------------------------|-----|----------------------------|---------------------|---------------------|
| Breaking capacity kA rms | | 15 | 20 | 25 |
| Downstream | | Enhanced breaking capacity | | |
| EZC100B | 5 | - | - | - |
| EZC100F | 7.5 | - | - | - |
| EZC100N | 10 | - | 15 | 15 |
| EZC100H | 20 | - | - | - |

| Upstream | | EZC400N | EZC400H | NB400 NB630 | NSX400N NSX630N | NSX400H NSX630H |
|--------------------------|-----|----------------------------|---------|----------------|--------------------|--------------------|
| Breaking capacity kA rms | | 36 | 50 | 30 | 42 | 65 |
| Downstream | | Enhanced breaking capacity | | | | |
| EZC100B | 5 | - | - | - | - | - |
| EZC100F | 7.5 | - | - | - | - | - |
| EZC100N | 10 | 15 | 15 | 15 | 15 | 25 |
| EZC100H | 25 | - | 30 | 30 | 30 | 30 |
| EZC250F | 15 | 20 | 20 | - | - | - |
| EZC/EZCV250N | 20 | - | 25 | 25 | 25 | 30 |
| EZC/EZCV250H | 25 | - | 30 | 30 | 30 | 30 |



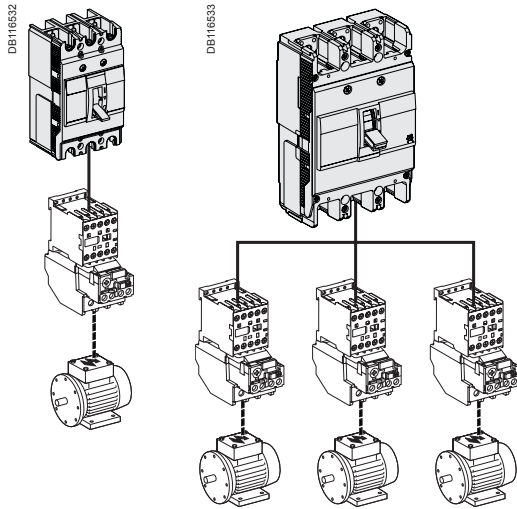

A circuit supplying a motor may include one, two, three or four switchgear or controlgear devices fulfilling one or more functions.

When a number of devices are used, they must be coordinated to ensure optimum operation of the motor.

Protection of a motor circuit involves a number of parameters that depend on:

- the application (type of machine driven, operating safety, starting frequency, etc.)
- the level of service continuity imposed by the load or the application
- the applicable standards to ensure protection of life and property.

The necessary electrical functions are of very different natures:

- short circuit protection
- overload protection dedicated for motor
- control (generally with high endurance levels)
- isolation.

Protection functions

Disconnection functions:

Isolate a motor circuit prior to maintenance operations.

Short-circuit protection:

Protect the starter and the cables against major overcurrents ($> 10 I_n$).

This type of protection is provided by a circuit breaker.

Control:

Start and stop the motor and, if applicable:

- gradual acceleration
- speed control.

Overload protection:

Protect the starter and the cables against minor overcurrents ($< 10 I_n$).

Thermal relays provide protection against this type of fault. They may be:

- integrated in the short-circuit protective device
- separate.

Additional specific protection:

- limitative fault protection (while the motor is running)
- preventive fault protection (monitoring of motor insulation with motor off).

Overloads ($I < 10 I_n$)

An overload may be caused by:

- an electrical problem, for instance on the mains (loss of a phase, voltage outside tolerances, etc.)
- a mechanical problem, for instance excessive torque due to abnormally high demands by the process or motor damage (bearing vibrations, etc.).

A further consequence of these two origins is excessively long starting.

Impedance short-circuit ($10 < I < 50 I_n$)

Deterioration of motor-winding insulation is the primary cause.

Short-circuit ($I > 50 I_n$)

This type of fault is relatively rare. A possible cause may be a connection error during maintenance.

Protection against insulation faults

This type of protection may be provided by:

- a residual current device (RCD)
- an insulation monitoring device (IMD).

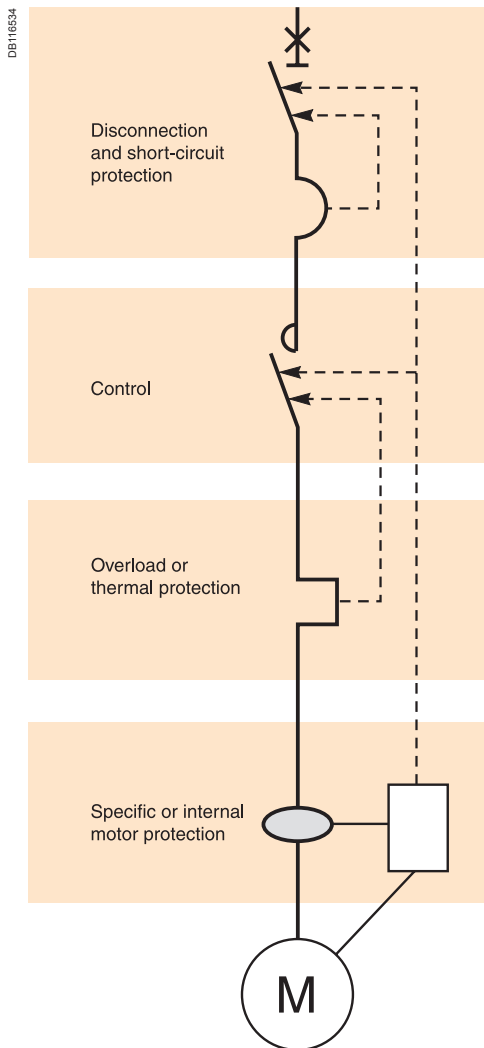

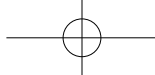

| Motors P (kW) | 220/230 V I (A) | 240 V I (A) | Circuit breakers | | 380/400 V I (A) | 415 V I (A) | Circuit breakers | | 440 V I (A) | Circuit breakers | |
|------------------|--------------------|----------------|------------------|------------------|--------------------|----------------|------------------|------------------|----------------|------------------|------------------|
| | | | Type | Rating In (A) | | | Type | Rating In (A) | | Type | Rating In (A) |
| 0.37 | 2 | 1.8 | EZC100 | 20 | 1.2 | 1.1 | EZC100 | 20 | 1 | EZC100 | 20 |
| 0.55 | 2.8 | 2.6 | | 20 | 1.6 | 1.5 | | 20 | 1.4 | | 20 |
| 0.75 | 3.5 | 3.2 | | 20 | 2 | 1.8 | | 20 | 1.7 | | 20 |
| 1.1 | 5 | 4.5 | | 20 | 2.8 | 2.6 | | 20 | 2.4 | | 20 |
| 1.5 | 6.5 | 6 | | 20 | 3.7 | 3.4 | | 20 | 3.1 | | 20 |
| 2.2 | 9 | 8 | | 20 | 5.3 | 4.8 | | 20 | 4.5 | | 20 |
| 3 | 12 | 11 | | 20 | 7 | 6.5 | | 20 | 5.8 | | 20 |
| 4 | 15 | 14 | | 20 | 9 | 8.2 | | 20 | 8 | | 20 |
| 5.5 | 21 | 19 | | 40 | 12 | 11 | | 20 | 10.5 | | 20 |
| 7.5 | 28 | 25 | | 60 | 16 | 14 | | 20 | 13.7 | | 20 |
| 10 | 36 | 33 | | 60 | 21 | 19 | | 40 | 19 | | 40 |
| 11 | 39 | 36 | | 80 | 23 | 21 | | 40 | 20 | | 40 |
| 15 | 52 | 48 | | 80 | 30 | 28 | | 60 | 26.5 | | 60 |
| 18.5 | 63 | 59 | | 80 | 37 | 34 | | 60 | 33 | | 60 |
| 22 | 75 | 70 | EZC250 | 125 | 43 | 40 | | 80 | 39 | | 60 |
| 30 | 100 | 95 | | 160 | 59 | 55 | EZC250 | 125 | 52 | | 80 |
| 37 | 125 | 115 | | 250 | 72 | 66 | | 150 | 63 | EZC250 | 125 |
| 45 | 150 | 140 | | 250 | 85 | 80 | | 160 | 76 | | 150 |

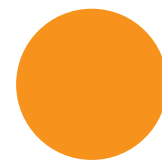

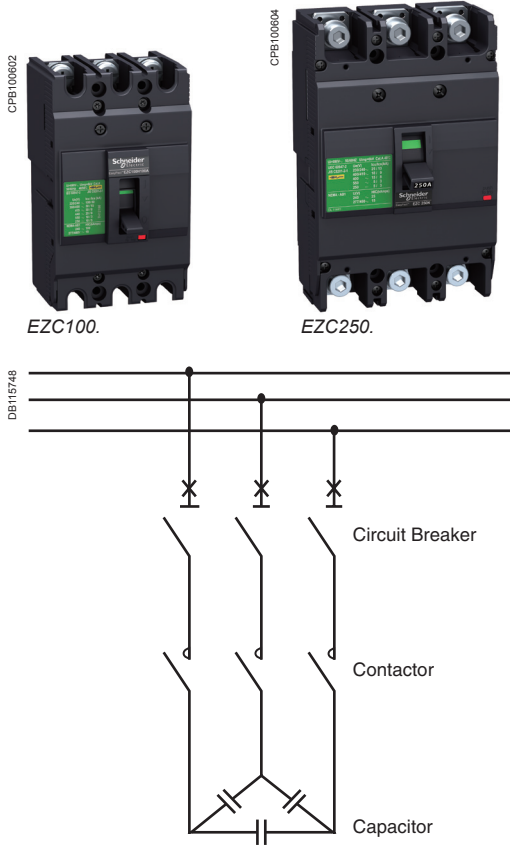

EasyPact EZC circuit breaker is suitable for capacitor protection following the rules below:

■ **Inc = Nominal current of the capacitor**

$$I_{nc} = \frac{Q_c}{U\sqrt{3}}$$

Inc = Nominal Current Capacitor (A)
 Qc = Reactive power (kVAR)
 U = Nominal Voltage (V)

■ **Inb = Nominal current of the circuit breaker (EzC)**

- Inb = 1.36 x Inc for standard equipment
- Inb = 1.5 x Inc for overrated type equipment
- Inb = 1.12 x Inc for detuned type equipment: 2.7 tuning
- Inb = 1.19 x Inc for detuned type equipment: 3.8 tuning
- Inb = 1.31 x Inc for detuned type equipment: 4.3 tuning
- the short-circuit (magnetic) protection-setting thresholds must enable passage of the energising transients: 10 x Inc for standard, overrated and detuned type equipment.

■ **Icu = Ultimate breaking capacity of the circuit breaker (EzC)**

Icu short-circuit level is given by the installation.

Example:

Table at 400 V AC - 3 phases 50 Hz for standard equipment.

| Reactive power (kVAR) | Inc (A) | Inb (A) | Breaking capacity to Circuit Breaker | |
|-----------------------|---------|---------|--------------------------------------|-------------|
| | | | 15 kA | 30 kA |
| 7.5 | 11 | 15 | EZC100N3015 | EZC100H3015 |
| 10 | 14 | 20 | EZC100N3020 | EZC100H3020 |
| 15 | 22 | 30 | EZC100N3030 | EZC100H3030 |
| 20 | 29 | 40 | EZC100N3040 | EZC100H3040 |
| 30 | 43 | 60 | EZC100N3060 | EZC100H3060 |
| 40 | 58 | 80 | EZC100N3080 | EZC100H3080 |
| 50 | 72 | 100 | EZC100N3100 | EZC100H3100 |
| 60 | 87 | 118 | EZC250F3125 | EZC250H3125 |
| 75 | 108 | 147 | EZC250F3150 | EZC250H3150 |
| 100 | 144 | 196 | EZC250F3200 | EZC250H3200 |

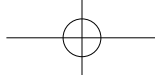

| | |
|--|------|
| <i>Presentation</i> | // |
| <i>Functions and characteristics</i> | A-1 |
| <i>Busbars</i> | B-1 |
| <i>Installation guide</i> | C-1 |
| EZC100N/H 1P/2P Circuit breaker | D-2 |
| EZC100B/F/N/H 3P Circuit breaker | D-3 |
| EZC100N/H 4P Circuit breaker | D-4 |
| EZC100N/H/B/F Accessories | D-5 |
| EZC250F/N/H 2P/3P Circuit breaker | D-7 |
| EZC250N/H 4P Circuit breaker | D-8 |
| EZCV250N/H 3P/4P Earth-leakage circuit breaker | D-9 |
| EZC250F/N/H, EZCV250N/H Accessories | D-10 |
| EZC400N/H 3P/4P Circuit breaker | D-12 |
| EZC630N/H 3P/4P Circuit breaker | D-13 |
| EZC400/630N/H Accessories | D-14 |
| EasyPact EZC Busbar Type-tested solution IEC 60439 | D-17 |

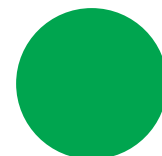

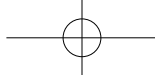

Catalogue numbers

EZC100N/H 1P/2P

Circuit breaker

EasyPact EZC100N 1P 18 kA 220/240 V

With thermal magnetic trip unit

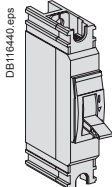

| Rating | 1P 1t |
|--------|-------------|
| 15 A | EZC100N1015 |
| 16 A | EZC100N1016 |
| 20 A | EZC100N1020 |
| 25 A | EZC100N1025 |
| 30 A | EZC100N1030 |
| 32 A | EZC100N1032 |
| 40 A | EZC100N1040 |
| 45 A | EZC100N1045 |
| 50 A | EZC100N1050 |
| 60 A | EZC100N1060 |
| 63 A | EZC100N1063 |
| 75 A | EZC100N1075 |
| 80 A | EZC100N1080 |
| 100 A | EZC100N1100 |

EasyPact EZC100H 1P 25 kA - 2P 50 kA 220/240 V

With thermal magnetic trip unit

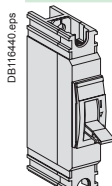

1P

| Rating | 1P 1t | 2P 2t |
|--------|-------------|-------------|
| 15 A | EZC100H1015 | EZC100H2015 |
| 16 A | EZC100H1016 | EZC100H2016 |
| 20 A | EZC100H1020 | EZC100H2020 |
| 25 A | EZC100H1025 | EZC100H2025 |
| 30 A | EZC100H1030 | EZC100H2030 |
| 32 A | EZC100H1032 | EZC100H2032 |
| 40 A | EZC100H1040 | EZC100H2040 |
| 45 A | EZC100H1045 | EZC100H2045 |
| 50 A | EZC100H1050 | EZC100H2050 |
| 60 A | EZC100H1060 | EZC100H2060 |
| 63 A | EZC100H1063 | EZC100H2063 |
| 75 A | EZC100H1075 | EZC100H2075 |
| 80 A | EZC100H1080 | EZC100H2080 |
| 100 A | EZC100H1100 | EZC100H2100 |

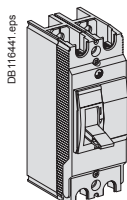

2P

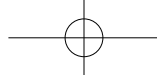

EZC100B/F/N/H 3P

Circuit breaker

EasyPact EZC100B 3P 7.5 kA 400/415 V

With thermal magnetic trip unit

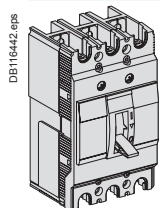

| Rating | 3P 3t |
|--------|-------------|
| 15 A | EZC100B3015 |
| 16 A | EZC100B3016 |
| 20 A | EZC100B3020 |
| 25 A | EZC100B3025 |
| 30 A | EZC100B3030 |
| 32 A | EZC100B3032 |
| 40 A | EZC100B3040 |
| 45 A | EZC100B3045 |
| 50 A | EZC100B3050 |
| 60 A | EZC100B3060 |

EasyPact EZC100F 3P 10 kA 400/415 V

With thermal magnetic trip unit

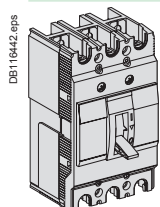

| Rating | 3P 3t |
|--------|-------------|
| 15 A | EZC100F3015 |
| 16 A | EZC100F3016 |
| 20 A | EZC100F3020 |
| 25 A | EZC100F3025 |
| 30 A | EZC100F3030 |
| 32 A | EZC100F3032 |
| 40 A | EZC100F3040 |
| 45 A | EZC100F3045 |
| 50 A | EZC100F3050 |
| 60 A | EZC100F3060 |
| 63 A | EZC100F3063 |
| 75 A | EZC100F3075 |
| 80 A | EZC100F3080 |
| 100 A | EZC100F3100 |

EasyPact EZC100N 3P 15 kA 400/415 V

With thermal magnetic trip unit

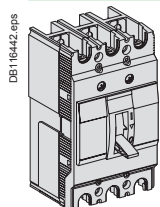

| Rating | 3P 3t |
|--------|-------------|
| 15 A | EZC100N3015 |
| 16 A | EZC100N3016 |
| 20 A | EZC100N3020 |
| 25 A | EZC100N3025 |
| 30 A | EZC100N3030 |
| 32 A | EZC100N3032 |
| 40 A | EZC100N3040 |
| 45 A | EZC100N3045 |
| 50 A | EZC100N3050 |
| 60 A | EZC100N3060 |
| 63 A | EZC100N3063 |
| 75 A | EZC100N3075 |
| 80 A | EZC100N3080 |
| 100 A | EZC100N3100 |

EasyPact EZC100H 3P 30 kA 400/415 V

With thermal magnetic trip unit

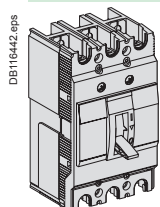

| Rating | 3P 3t |
|--------|-------------|
| 15 A | EZC100H3015 |
| 16 A | EZC100H3016 |
| 20 A | EZC100H3020 |
| 25 A | EZC100H3025 |
| 30 A | EZC100H3030 |
| 32 A | EZC100H3032 |
| 40 A | EZC100H3040 |
| 45 A | EZC100H3045 |
| 50 A | EZC100H3050 |
| 60 A | EZC100H3060 |
| 63 A | EZC100H3063 |
| 75 A | EZC100H3075 |
| 80 A | EZC100H3080 |
| 100 A | EZC100H3100 |



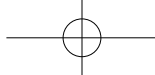

Catalogue numbers

EZC100N/H 4P

Circuit breaker

EasyPact EZC100N 4P 15 kA 400/415 V

With thermal magnetic trip unit

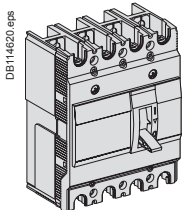

| Rating | 4P 3t |
|--------|-------------|
| 15 A | EZC100N4015 |
| 16 A | EZC100N4016 |
| 20 A | EZC100N4020 |
| 25 A | EZC100N4025 |
| 30 A | EZC100N4030 |
| 32 A | EZC100N4032 |
| 40 A | EZC100N4040 |
| 45 A | EZC100N4045 |
| 50 A | EZC100N4050 |
| 60 A | EZC100N4060 |
| 63 A | EZC100N4063 |
| 75 A | EZC100N4075 |
| 80 A | EZC100N4080 |
| 100 A | EZC100N4100 |

EasyPact EZC100H 4P 30 kA 400/415 V

With thermal magnetic trip unit

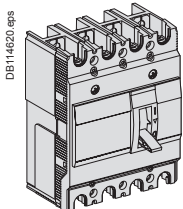

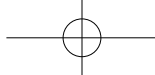

| Rating | 4P 3t |
|--------|-------------|
| 15 A | EZC100H4015 |
| 16 A | EZC100H4016 |
| 20 A | EZC100H4020 |
| 25 A | EZC100H4025 |
| 30 A | EZC100H4030 |
| 32 A | EZC100H4032 |
| 40 A | EZC100H4040 |
| 45 A | EZC100H4045 |
| 50 A | EZC100H4050 |
| 60 A | EZC100H4060 |
| 63 A | EZC100H4063 |
| 75 A | EZC100H4075 |
| 80 A | EZC100H4080 |
| 100 A | EZC100H4100 |



EZC100N/H/B/F Accessories

Connection accessories



Cable lugs

| | | | | |
|---|--------|---------------------------------------|----------|------------|
|  DB100821.eps | ≤ 50 A | Cables from 2.5 to 16 mm ² | Set of 2 | EZALUG0502 |
| | | | Set of 3 | EZALUG0503 |
|  DB100822.eps | > 50 A | Cables from 10 to 50 mm ² | Set of 2 | EZALUG1002 |
| | | | Set of 3 | EZALUG1003 |

Spreaders

| | | | | |
|---|--------------------------|--|----------|-----------|
|  DB111674.eps | Spreaders for 3P breaker | | Set of 3 | EZASPDR3P |
| | Spreaders for 4P breaker | | Set of 4 | EZASPDR4P |

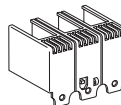
Terminal shields

| | | | | |
|---|---------------------------------|--|----------|-----------|
|  DB100824.eps | Terminal shields for 3P breaker | | Set of 2 | EZATSHD3P |
| | Terminal shields for 4P breaker | | Set of 2 | EZATSHD4P |
|  DB100825.eps | | | | |

Sealing screws



| | | | | |
|---|----------------|--|----------|---------|
|  DB100825.eps | Sealing screws | | Set of 2 | EZASSCR |
|---|----------------|--|----------|---------|

Phase barriers

| | | | | |
|---|----------------|--|----------|----------|
|  DB100826.eps | Phase barriers | | Set of 2 | EZAFASB2 |
|---|----------------|--|----------|----------|

Electrical auxiliaries

Indication contacts

| | | | | |
|---|---|--|--|---------|
|  DB111662.eps | Auxiliary switch (AX) | | | EZAUX10 |
| | | | | |
|  DB111663.eps | Alarm switch (AL) | | | EZAUX01 |
| | | | | |
|  DB111669.eps | Auxiliary switch + alarm switch (AX + AL) | | | EZAUX11 |

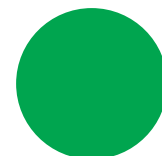

Electrical auxiliaries (cont.)

Voltage releases

Db100830.eps

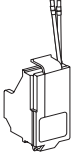

Shunt trip (SHT)

| | Voltage | MX/SHT |
|----|-----------|-------------|
| AC | 100-130 V | EZASHT100AC |
| | 200-277 V | EZASHT200AC |
| | 380-480 V | EZASHT380AC |
| DC | 24 V | EZASHT024DC |
| | 48 V | EZASHT048DC |

Db100831.eps

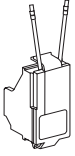

Under voltage release (UVR)

| | Voltage | MN/UVR |
|----|-----------|-------------|
| AC | 110-130 V | EZAUVR110AC |
| | 200-240 V | EZAUVR200AC |
| | 277 V | EZAUVR277AC |
| | 380-415 V | EZAUVR380AC |
| | 440-480 V | EZAUVR440AC |
| DC | 24 V | EZAUVR024DC |
| | 48 V | EZAUVR048DC |
| | 125 V | EZAUVR125DC |

Rotary handles

Direct rotary handle (for 3/4P breaker)

Db100832.eps



| | |
|-----------------------------------|------------|
| Direct rotary handle (black) | EZAROTDS |
| Direct rotary handle (red/yellow) | EZAROTDSRY |

Extended rotary handle (for 3/4P breaker)

Db100833.eps

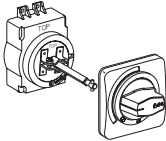

| | |
|-------------------------------------|-----------|
| Extended rotary handle (black) | EZAROTE |
| Extended rotary handle (red/yellow) | EZAROTERY |

Locks

Padlocking system

Db100834.eps



| | |
|-------------------|---------|
| Padlocking system | EZALOCK |
|-------------------|---------|

Installation accessory

DIN rail adaptor

Db100835.eps

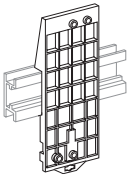

| | |
|--|---------|
| For 2 x 1P or 1 x 2P or 1 x 3P breaker Note: for 4P breaker, use 2 adaptors | EZADINR |
|--|---------|

Plug-in

Plug-in 100 A

Db117582.eps

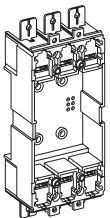

| | |
|--|-----------|
| Kit, plug-in base 3P 15 A-50 A | EZAPLUG3L |
| Kit, plug-in base 3P 60 A-100 A | EZAPLUG3H |
| Fishbone connectors set of 3 | EZAFSHB3 |
| Plug-in connectors 15 A-50 A set of 2 | EZAPCON1L |
| Plug-in connectors 60 A-100 A set of 2 | EZAPCON1H |

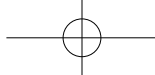

EZC250F/N/H 2P/3P

Circuit breaker

EasyPact EZC250F 3P 18 kA 400/415 V

With thermal magnetic trip unit

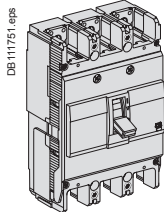

| Rating | 3P 3t |
|--------|-------------|
| 100 A | EZC250F3100 |
| 125 A | EZC250F3125 |
| 150 A | EZC250F3150 |
| 160 A | EZC250F3160 |
| 175 A | EZC250F3175 |
| 200 A | EZC250F3200 |
| 225 A | EZC250F3225 |
| 250 A | EZC250F3250 |

EasyPact EZC250N 3P 25 kA 400/415 V

With thermal magnetic trip unit

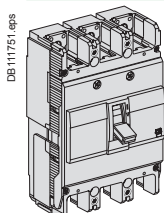

| Rating | 3P 3t |
|--------|-------------|
| 100 A | EZC250N3100 |
| 125 A | EZC250N3125 |
| 150 A | EZC250N3150 |
| 160 A | EZC250N3160 |
| 175 A | EZC250N3175 |
| 200 A | EZC250N3200 |
| 225 A | EZC250N3225 |
| 250 A | EZC250N3250 |

EasyPact EZC250H 2/3P 36 kA 400/415 V

With thermal magnetic trip unit

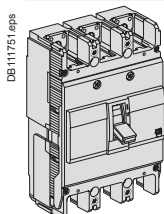

| Rating | 2P 2t | 3P 3t |
|--------|-------------|-------------|
| 100 A | EZC250H2100 | EZC250H3100 |
| 125 A | EZC250H2125 | EZC250H3125 |
| 150 A | EZC250H2150 | EZC250H3150 |
| 160 A | EZC250H2160 | EZC250H3160 |
| 175 A | EZC250H2175 | EZC250H3175 |
| 200 A | EZC250H2200 | EZC250H3200 |
| 225 A | EZC250H2225 | EZC250H3225 |
| 250 A | EZC250H2250 | EZC250H3250 |

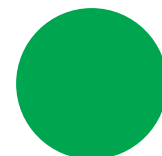



Catalogue numbers

EZC250N/H 4P

Circuit breaker

EasyPact EZC250N 4P 25 kA 400/415 V

With thermal magnetic trip unit

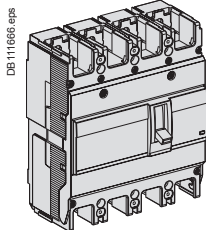

| Rating | 4P 3t | 4P 4t |
|--------|-------------|--------------|
| 63 A | EZC250N4063 | EZC250N44063 |
| 80 A | EZC250N4080 | EZC250N44080 |
| 100 A | EZC250N4100 | EZC250N44100 |
| 125 A | EZC250N4125 | EZC250N44125 |
| 150 A | EZC250N4150 | EZC250N44150 |
| 160 A | EZC250N4160 | EZC250N44160 |
| 175 A | EZC250N4175 | EZC250N44175 |
| 200 A | EZC250N4200 | EZC250N44200 |
| 225 A | EZC250N4225 | EZC250N44225 |
| 250 A | EZC250N4250 | EZC250N44250 |

EasyPact EZC250H 4P 36 kA 400/415 V

With thermal magnetic trip unit

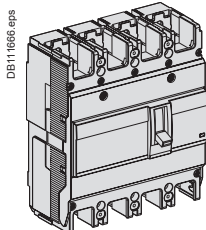

| Rating | 4P 3t | 4P 4t |
|--------|-------------|--------------|
| 63 A | EZC250H4063 | EZC250H44063 |
| 80 A | EZC250H4080 | EZC250H44080 |
| 100 A | EZC250H4100 | EZC250H44100 |
| 125 A | EZC250H4125 | EZC250H44125 |
| 150 A | EZC250H4150 | EZC250H44150 |
| 160 A | EZC250H4160 | EZC250H44160 |
| 175 A | EZC250H4175 | EZC250H44175 |
| 200 A | EZC250H4200 | EZC250H44200 |
| 225 A | EZC250H4225 | EZC250H44225 |
| 250 A | EZC250H4250 | EZC250H44250 |

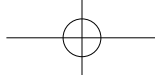

EZCV250N/H 3P/4P

Earth-leakage circuit breaker

EasyPact EZCV250N 3P 25 kA 400/415 V

With thermal magnetic trip unit and earth leakage protection

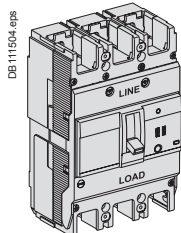

| Rating | 3P 3t |
|--------|--------------|
| 63 A | EZCV250N3063 |
| 80 A | EZCV250N3080 |
| 100 A | EZCV250N3100 |
| 125 A | EZCV250N3125 |
| 150 A | EZCV250N3150 |
| 160 A | EZCV250N3160 |
| 175 A | EZCV250N3175 |
| 200 A | EZCV250N3200 |
| 225 A | EZCV250N3225 |
| 250 A | EZCV250N3250 |

EasyPact EZCV250H 3P 36 kA 400/415 V

With thermal magnetic trip unit and earth leakage protection

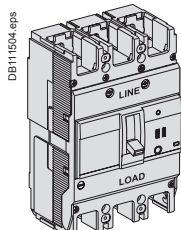

| Rating | 3P 3t |
|--------|--------------|
| 63 A | EZCV250H3063 |
| 80 A | EZCV250H3080 |
| 100 A | EZCV250H3100 |
| 125 A | EZCV250H3125 |
| 150 A | EZCV250H3150 |
| 160 A | EZCV250H3160 |
| 175 A | EZCV250H3175 |
| 200 A | EZCV250H3200 |
| 225 A | EZCV250H3225 |
| 250 A | EZCV250H3250 |

EasyPact EZCV250N 4P 25 kA 400/415 V

With thermal magnetic trip unit and earth leakage protection

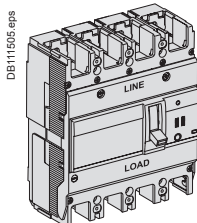

| Rating | 4P 3t | 4P 4t |
|--------|--------------|---------------|
| 63 A | EZCV250N4063 | EZCV250N44063 |
| 80 A | EZCV250N4080 | EZCV250N44080 |
| 100 A | EZCV250N4100 | EZCV250N44100 |
| 125 A | EZCV250N4125 | EZCV250N44125 |
| 150 A | EZCV250N4150 | EZCV250N44150 |
| 160 A | EZCV250N4160 | EZCV250N44160 |
| 175 A | EZCV250N4175 | EZCV250N44175 |
| 200 A | EZCV250N4200 | EZCV250N44200 |
| 225 A | EZCV250N4225 | EZCV250N44225 |
| 250 A | EZCV250N4250 | - |

EasyPact EZCV250H 4P 36 kA 400/415 V

With thermal magnetic trip unit and earth leakage protection

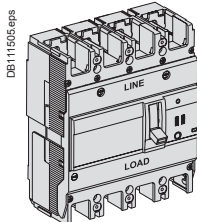

| Rating | 4P 3t | 4P 4t |
|--------|--------------|---------------|
| 63 A | EZCV250H4063 | EZCV250H44063 |
| 80 A | EZCV250H4080 | EZCV250H44080 |
| 100 A | EZCV250H4100 | EZCV250H44100 |
| 125 A | EZCV250H4125 | EZCV250H44125 |
| 150 A | EZCV250H4150 | EZCV250H44150 |
| 160 A | EZCV250H4160 | EZCV250H44160 |
| 175 A | EZCV250H4175 | EZCV250H44175 |
| 200 A | EZCV250H4200 | EZCV250H44200 |
| 225 A | EZCV250H4225 | EZCV250H44225 |
| 250 A | EZCV250H4250 | - |

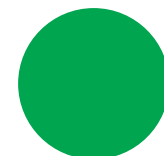

Connection accessories

Cable lugs

| | | | | |
|---|-------|---------------------------------------|----------|------------|
|  | 250 A | Cables from 42 to 152 mm ² | Set of 3 | EZELUG2503 |
| | | | Set of 4 | EZELUG2504 |

Terminal extensions

| | | | | |
|---|-----------------------------------|--|----------|----------|
|  | Terminal extension for 3P breaker | | Set of 3 | EZETEX |
| | Terminal extension for 4P breaker | | Set of 4 | EZETEX4P |

Spreaders

| | | | | |
|---|--------------------------|--|----------|-----------|
|  | Spreaders for 3P breaker | | Set of 3 | EZESPDR3P |
| | Spreaders for 4P breaker | | Set of 4 | EZESPDR4P |

Terminal shields

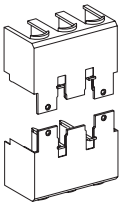



| | | | | |
|--|---|--|----------|------------|
|  | Terminal shields for 3P breaker (60 mm depth) | | Set of 2 | EZETSHD3P |
| | Terminal shields for 3P breaker (68 mm depth) | | Set of 2 | EZETSHD3PN |
| | Terminal shields for 4P breaker (68 mm depth) | | Set of 2 | EZETSHD4PN |

Phase barriers

| | | | | |
|---|--------------------------------|--|----------|-----------|
|  | Phase barriers for 60 mm depth | | Set of 2 | EZEFASB2 |
| | Phase barriers for 68 mm depth | | Set of 3 | EZEFASB3N |

Electrical auxiliaries

Indication contacts

| | | | | |
|---|---|--|--|---------|
|  | Auxiliary switch (AX) | | | EZEAX |
|  | Alarm switch (AL) | | | EZEAL |
|  | Auxiliary switch + alarm switch (AX + AL) | | | EZEAXAL |
|  | Earth-leakage alarm switch (ALV) (only for EZCV250) | | | EZEALV |



Electrical auxiliaries (cont.)

Voltage releases

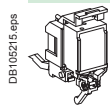

DB105215.eps

Shunt trip (SHT)

| | Voltage | MX/SHT |
|----|-----------|-------------|
| AC | 100-120 V | EZESHT100AC |
| | 120-130 V | EZESHT120AC |
| | 200-240 V | EZESHT200AC |
| | 277 V | EZESHT277AC |
| | 380-440 V | EZESHT400AC |
| DC | 440-480 V | EZESHT440AC |
| | 24 V | EZESHT024DC |
| | 48 V | EZESHT048DC |

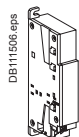

(UVR)

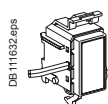

DB111632.eps

(UVRN)

Under voltage release

| | Voltage | MN/UVR | MN/UVR ⁽¹⁾ |
|----|-----------|-------------|-----------------------|
| AC | 110-130 V | EZEUVR110AC | EZEUVRN110AC |
| | 200-240 V | EZEUVR200AC | EZEUVRN200AC |
| | 277 V | EZEUVR277AC | EZEUVRN277AC |
| | 380-415 V | EZEUVR400AC | EZEUVRN400AC |
| | 440-480 V | EZEUVR440AC | EZEUVRN440AC |
| DC | 24 V | EZEUVR024DC | EZEUVRN024DC |
| | 48 V | EZEUVR048DC | EZEUVRN048DC |
| | 125 V | EZEUVR125DC | EZEUVRN125DC |

(1) Only EZC250-4P and EZCV250-3/4P

Rotary handles

Direct rotary handle

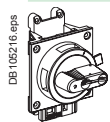

DB105216.eps

| | |
|-----------------------------------|------------|
| Direct rotary handle (black) | EZEROTDS |
| Direct rotary handle (red/yellow) | EZEROTDSRY |

Extended rotary handle

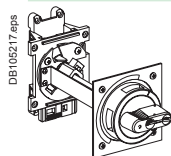

DB105217.eps

| | |
|-------------------------------------|-----------|
| Extended rotary handle (black) | EZEROTE |
| Extended rotary handle (red/yellow) | EZEROTERY |

Locks

Padlocking system



DB105218.eps

| | |
|--|----------|
| Padlocking system for EZC250-3P | EZELOCK |
| Padlocking system for EZC250-4P and EZCV250-3/4P | EZELOCKN |

Plug-in

Plug-in 250 A

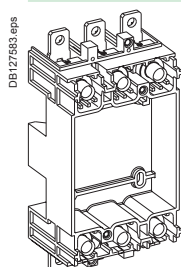

DB127583.eps

| | |
|--|-----------|
| Kit, plug-in base 3P 100 A-250 A 60 mm breaker | EZEPLUG3L |
| Kit, plug-in base 3P 100 A-250 A 68 mm breaker | EZEPLUG3H |
| Kit, plug-in base 4P 100 A-250 A 68 mm breaker | EZEPLUG4 |
| Kit, plug-in connectors 100 A-250 A set of 2 | EZEPCON1 |



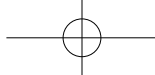

Catalogue numbers

EZC400N/H 3P/4P Circuit breaker

EasyPact EZC400N 3P 36 kA 400/415 V

With thermal magnetic trip unit

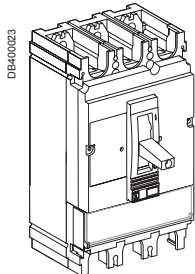

| Rating | 3P 3t |
|--------|--------------|
| 320 A | EZC400N3320N |
| 350 A | EZC400N3350N |
| 400 A | EZC400N3400N |

EasyPact EZC400H 3P 50 kA 400/415 V

With thermal magnetic trip unit

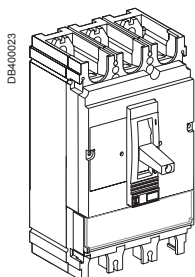

| Rating | 3P 3t |
|--------|--------------|
| 320 A | EZC400H3320N |
| 350 A | EZC400H3350N |
| 400 A | EZC400H3400N |

EasyPact EZC400N 4P 36 kA 400/415 V

With thermal magnetic trip unit

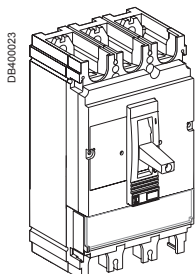

| Rating | 4P 3t | 4P 4t |
|--------|--------------|---------------|
| 320 A | EZC400N4320N | EZC400N44320N |
| 350 A | EZC400N4350N | EZC400N44350N |
| 400 A | EZC400N4400N | EZC400N44400N |

EasyPact EZC400H 4P 50 kA 400/415 V

With thermal magnetic trip unit

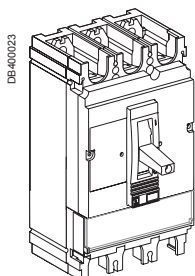

| Rating | 4P 3t | 4P 4t |
|--------|--------------|---------------|
| 320 A | EZC400H4320N | EZC400H44320N |
| 350 A | EZC400H4350N | EZC400H44350N |
| 400 A | EZC400H4400N | EZC400H44400N |

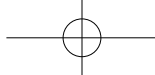

EZC630N/H 3P/4P

Circuit breaker

EasyPact EZC630N 3P 36 kA 400/415 V

With thermal magnetic trip unit

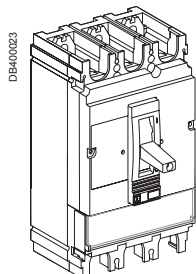

| Rating | 3P 3t |
|--------|--------------|
| 400 A | EZC630N3400N |
| 500 A | EZC630N3500N |
| 600 A | EZC630N3600N |

EasyPact EZC630H 3P 50 kA 400/415 V

With thermal magnetic trip unit

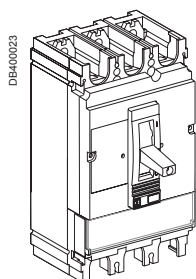

| Rating | 3P 3t |
|--------|--------------|
| 400 A | EZC630H3400N |
| 500 A | EZC630H3500N |
| 600 A | EZC630H3600N |

EasyPact EZC630N 4P 36 kA 400/415 V

With thermal magnetic trip unit

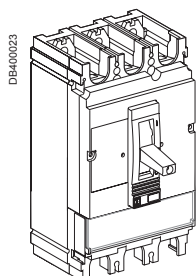

| Rating | 4P 3t | 4P 4t |
|--------|--------------|---------------|
| 400 A | EZC630N4400N | EZC630N44400N |
| 500 A | EZC630N4500N | EZC630N44500N |
| 600 A | EZC630N4600N | EZC630N44600N |

EasyPact EZC630H 4P 50 kA 400/415 V

With thermal magnetic trip unit

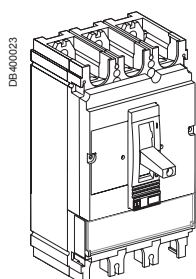

| Rating | 4P 3t | 4P 4t |
|--------|--------------|---------------|
| 400 A | EZC630H4400N | EZC630H44400N |
| 500 A | EZC630H4500N | EZC630H44500N |
| 600 A | EZC630H4600N | EZC630H44600N |

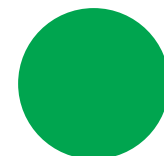

Connection accessories (Cu or Al)

Rear connections

DB112225

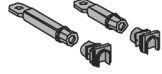

| | |
|---------|----------|
| 2 short | LV432475 |
| 2 long | LV432476 |

Cable connectors ⁽¹⁾

E22040



| | | |
|---|----------|----------|
| Aluminium connector 1x (35 to 300 mm ²) | Set of 3 | LV432479 |
| | Set of 4 | LV432480 |

E22041



| | | |
|---|----------|----------|
| Aluminium connector 2x (35 to 240 mm ²) | Set of 3 | LV432481 |
| | Set of 4 | LV432482 |

| | | |
|--|-----------|----------|
| Voltage plug for aluminium connector 1 or 2 cables | Set of 10 | LV429348 |
|--|-----------|----------|

Terminal extension ⁽¹⁾

E21276



| | | |
|--------------------------------|----------|----------|
| Right-angle terminal extension | Set of 3 | LV432484 |
| | Set of 4 | LV432485 |

E21276



| | | |
|------------------------------|----------|----------|
| Edgewise terminal extensions | Set of 3 | LV432486 |
| | Set of 4 | LV432487 |

E21012



| | | | |
|-----------|---------|----|----------|
| Spreaders | 52.5 mm | 3P | LV432490 |
| | | 4P | LV432491 |
| | 70 mm | 3P | LV432492 |
| | | 4P | LV432493 |

Crimp lugs for copper cable ⁽¹⁾

E19802



| | | |
|-------------------------------|----------|----------|
| For cable 240 mm ² | Set of 3 | LV432500 |
| | Set of 4 | LV432501 |
| For cable 300 mm ² | Set of 3 | LV432502 |
| | Set of 4 | LV432503 |

Supplied with 2 (or 3) interphase barriers

Crimp lugs for aluminium cable ⁽¹⁾

E30908



| | | |
|-------------------------------|----------|----------|
| For cable 240 mm ² | Set of 3 | LV432504 |
| | Set of 4 | LV432505 |
| For cable 300 mm ² | Set of 3 | LV432506 |
| | Set of 4 | LV432507 |

Supplied with 2 (or 3) interphase barriers

Insulation accessories

E19819



| | | |
|--|----|----------|
| Short terminal shield, 45 mm (1 piece) | 3P | LV432591 |
| | 4P | LV432592 |

E19806



| | | |
|---------------------------------------|----|----------|
| Long terminal shield, 45 mm (1 piece) | 3P | LV432593 |
| | 4P | LV432594 |

Interphase barriers

| | | |
|---|----------|----------|
| Long terminal shielded for spreaders, 52,5mm (1 piece) (supplied with insulating plate) | Set of 6 | LV432570 |
|---|----------|----------|

| | | |
|------------------------------------|----|----------|
| 2 insulating screens (70 mm pitch) | 3P | LV432595 |
| | 4P | LV432596 |

| | | |
|--|----|----------|
| | 3P | LV432578 |
| | 4P | LV432579 |

(1) supplied with 2 or 3 interphase barriers

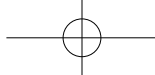

EZC400/630N/H (cont.)

Accessories(cont.)

Electrical auxiliaries

Auxiliary contacts (changeover)



E18608

| | |
|--|----------|
| OF or SD or SDE or SDV | 29450 |
| OF or SD or SDE or SDV low level | 29452 |
| SDE adaptor mandatory for trip unit TM | LV540050 |

Voltage releases



E18609

| | Voltage | MX | MN | |
|--|--|------------|----------|----------|
| AC | 24 V 50/60 Hz | LV429384 | LV429404 | |
| | 48 V 50/60 Hz | LV429385 | LV429405 | |
| | 110-130 V 50/60 Hz | LV429386 | LV429406 | |
| | 220-240 V 50/60 Hz and 208-277 V 60 Hz | LV429387 | LV429407 | |
| | 380-415 V 50 Hz and 440-480 V 60 Hz | LV429388 | LV429408 | |
| DC | Voltage | | | |
| | 12 V | LV429382 | LV429402 | |
| | 24 V | LV429390 | LV429410 | |
| | 30 V | LV429391 | LV429411 | |
| | 48 V | LV429392 | LV429412 | |
| | 60 V | LV429383 | LV429403 | |
| | 125 V | LV429393 | LV429413 | |
| | 250 V | LV429394 | LV429414 | |
| | MN 48 V 50/60 Hz with fixed time delay | | | |
| | Composed of: | MN 48 V DC | | LV429412 |
| | Delay unit 48 V 50/60 Hz | | LV429426 | |
| MN 220-240 V 50/60 Hz with fixed time delay | | | | |
| Composed of: | MN 250 V DC | | LV429414 | |
| | Delay unit 220-240 V 50/60 Hz | | LV429427 | |
| MN 48 V DC/AC 50/60 Hz with adjustable time delay | | | | |
| Composed of: | MN 48 V DC | | LV429412 | |
| | Delay unit 48 V 50/60 Hz | | 33680 | |
| MN 110-130 V DC/AC 50/60 Hz with adjustable time delay | | | | |
| Composed of: | MN 125 V DC | | LV429413 | |
| | Delay unit 110-130 V 50/60 Hz | | 33681 | |
| MN 220-250 V 50/60 Hz with adjustable time delay | | | | |
| Composed of: | MN 250 V DC | | LV429414 | |
| | Delay unit 220-250 V 50/60 Hz | | 33682 | |

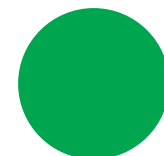



Catalogue numbers

EZC400/630N/H (cont.) Accessories (cont.)

Rotary handle

Direct rotary handle

Standard black handle

LV432597

E19811

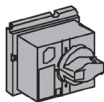

Extended rotary handle

Standard extended rotary handle

LV432598

E19812

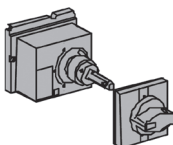

Locks

Toggle locking device for 1 to 3 padlocks

By removable device

29370

E19821



By fixed device

32631

E19813



Locking of the rotary handle

Keylock adaptor (keylock not included)

LV432604

Keylock (keylock adaptor not included)

Ronis 1351B.500

41940

Profalux KS5 B24 D4Z

42888

E19820

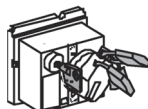

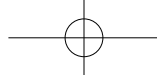

EasyPact EZC Busbar

Type-tested solution IEC 60439

Main Busbar

Main Busbar (EasyPact EZC 100/3P)

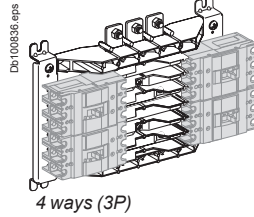

| | 250 A | 400 A | 630 A |
|---------|-----------|-----------|-----------|
| 4 ways | EZB250W04 | EZB400W04 | EZB630W04 |
| 6 ways | EZB250W06 | EZB400W06 | EZB630W06 |
| 8 ways | EZB250W08 | EZB400W08 | EZB630W08 |
| 10 ways | EZB250W10 | EZB400W10 | EZB630W10 |
| 12 ways | EZB250W12 | EZB400W12 | EZB630W12 |

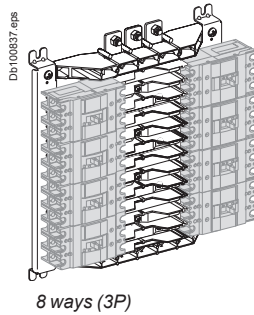

Branch extension (EasyPact EZC/Compact NSX/NB)

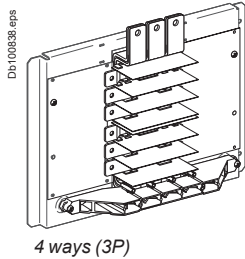

| | |
|--------|--------|
| 2 ways | EZBNS2 |
| 4 ways | EZBNS4 |

Main incoming connections (EasyPact EZC/Compact NSX/NB)

Main connectors

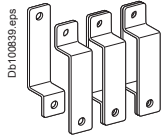

| | 250 A | 400 A | 630 A |
|-----------------|------------|------------|------------|
| Main connectors | EZB250MCNS | EZB400MCNS | EZB630MCNS |

To connect the main in-comer to EasyPact EZC busbar (EasyPact EZC/Compact NSX/NB or INS switch)

Mechanical lugs

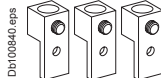

| | 250 A | 400 A | 630 A |
|----------------------------------|------------------------|------------------------|--|
| Incoming cable size | 16-150 mm ² | 35-300 mm ² | 25-240 mm ² 2 cables per phase |
| Lug kit for bare incoming cables | EZB250MLUG | EZB400MLUG | EZB630MLUG |

Connector caps



| | | |
|-------------------------------------|----------|-----------|
| Connector caps for 100 A out goings | Set of 3 | EZB100CAP |
| Connector caps for 250 A out goings | Set of 3 | EZB250CAP |

To isolate connections when branch breaker not installed

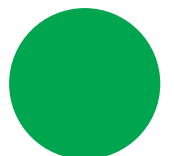

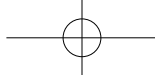

Notes

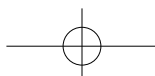
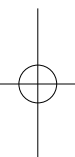

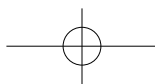
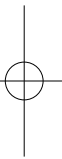
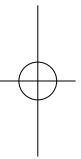
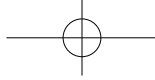

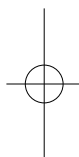
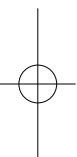
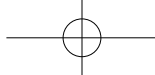

Schneider Electric Industries SAS
 35, rue Joseph Monier
 CS 30323
 F- 92506 Rueil Malmaison Cedex France

RCS Nanterre 954 503 439
 Capital social 896 313 776 €
www.schneider-electric.com

As standards, specifications and designs change from time to time, please ask for confirmation of the information given in this publication.

 *This document has been printed on ecological paper*

Design: Schneider Electric
 Photos: Schneider Electric
 Printed:

© 2012 - Schneider Electric - All rights reserved.

LVED212091EN

04-2013

